

Commonwealth of Pennsylvania Department of Transportation



Concrete Field Testing Technician Certification Training Manual

2023 Edition

PENNDOT Certified Concrete Field Technician Manual

INTRODUCTION	4
I. QUALITY CONTROL PRACTICES	6
a. Quality Control Plans	6
• CS-704	7
b. Transporting, Mixing and Placing Concrete	12
1. Definitions	12
2. Mixing Concrete for Placement	12
3. Transporting Concrete to the Project	12
4. Temperature Limitation for Concrete Placement	13
5. Discharge Times for Concrete Placement	13
6. Evaporation Rate for Bridge Deck Concrete	13
c. Communication Between Jobsite and Plant	14
d. Common Sense Quality Control in the Field	15
e. 408/704 Slump Quality Control Requirements	16
1. Slump Specification	16
2. Slump Specification Summary	17
f. Field Adjustment of Concrete Mixes	18
• POM B/6/17	19
g. Slump Adjustments at the Jobsite	20
h. Air Content Adjustments at the Jobsite	21
Review Questions	22
II. PROJECT DOCUMENTATION	24
a. TR-4221A Concrete Mix Design	25
b. CS-4220 Batcher Mixer Slip	26
c. Delivery Ticket Requirements	28
d. MCCID App & Concrete Field Inspectors Diary	30
1. Concrete Field Test Documentation	31
e. Reporting Compressive Strength Results CS-458A	37

f. W/C Ratio Determination	40
1. 408/704 Maximum W/C	40
2. Procedure	41
3. Example Using Batch-Mixer	41
4. Comparing Calculated W/C to Mix Design W/C	45
g. W/C Ratio Determination by Batch Plant Printout	46
1. Procedure	48
2. Example Using Batch Plant Printout	49
3. Blank Form for Batch Plant Printout Method	50
4. Comparing Calculated W/C to Mix Design W/C	51
Review Questions	53
III. ACCEPTANCE PROCESSES	55
a. Acceptance Testing	55
b. QC Cylinder Requirements	59
1. 7-day Compressive Strength	59
2. 28-day Compressive Strength	59
c. Verification Testing	60
1. Specification	60
d. Quality Assurance /Independent Assurance Testing	61
1. Specification	62
e. Section 501 Concrete Pavements	63
f. Section 506 RPS Cement Concrete Pavements	67
g. Section 530 Long Life Concrete Pavements	68
h. Accelerated Concrete for Patching	69
i. Placing Concrete in Water	70
1. Anti-Washout Admixture (AWA)	70
2. +25% Extra Cement Concrete	70
3. Specification	71
4. P.O.M. B/7/21	72
5. P.O.M. C/10/11	73
j. Pumping Concrete	74
k. Self-Consolidating Concrete (SCC)	75
l. Latex Modified Concrete or Mortar	76
m. Acceptance of Small Quantities of Materials	77

Review Questions	79
IV. PADOT CONCRETE TESTING PROCEDURES	81
a. Slump	81
b. Air Content, Pressure Method	81
c. Air Content, Volumetric Method	81
d. Density, Yield, Air Content Gravimetric Method	82
e. Temperature	82
f. Sampling Concrete	83
g. Concrete Test Cylinders	84
1. PTM 611 Section 13	85
2. PTM 611	86
h. Testing Facilities and Equipment – Section 704.1(d)3	96
i. Care of Concrete Test Cylinders	97
j. Compressive Strength of Molded Cylinders	99
k. Obtaining and Testing Cores of Concrete	100
l. Concrete Air Meter Calibrations	100
1. Forney Example	101
m. Packaging QA Cylinders being sent to LTS	102
Review Questions	103
REVIEW QUESTION ANSWERS	
I. Quality Control Practices	105
II. Project Documentation	106
III. Acceptance Processes	107
IV. PADOT Concrete Testing Procedures	108
REVIEW QUESTION CALCULATIONS	
II. Project Documentation	109
APPENDIX I	
PUB 408/2020 Change 5 Section 704	112
PUB 536/V9-22	133
Concrete Technician Certification Program	

INTRODUCTION

In an effort to assure quality of the Portland Cement Concrete used in Pennsylvania's pavements and structures, and to comply with Federal Highway Administration (FHWA) guidelines for concrete acceptance testing, the Pennsylvania Department of Transportation (PennDOT) has determined that anyone who is involved in the acceptance process for Portland Cement Concrete (PCC) on PennDOT projects must successfully complete the PennDOT Concrete Field Testing Technician Certification Program. This determination was coordinated with Industry representatives.

A Concrete Field Testing Technician is a person whose occupation requires training in the technique of testing concrete in the plastic and hardened states. Concrete has many properties, such as strength, durability, consistency, and workability. All of these properties are important for the satisfactory performance of the PCC. Testing concrete is the only way to determine if the concrete produced meets the specified limits of these properties.

Part One of this certification program is the American Concrete Institute (ACI) Concrete Field Testing Technician – Grade I course. Successful completion of the ACI course demonstrates an understanding of ASTM testing procedures for PCC. The purpose of ASTM methods is to standardize the test procedures for PCC for the entire industry.

Part Two of the PennDOT Concrete Field Testing Technician Certification includes a review of the applicable PennDOT PCC specifications and applicable AASHTO and Pennsylvania Test Methods (PTM's) used in the acceptance process. Additionally, Part Two will address certain PennDOT policies and procedures which address common problems that may arise in the field with regard to acceptance of PCC, performance of acceptance testing, and ultimately the ability of the specified concrete to meet or exceed its designed specifications.

This manual is intended to be a guide to assist in successfully completing the requirements of Part Two of the PennDOT Concrete Field Testing Technician Certification program.

There are numerous references to PennDOT Publication 408, as well as several of the applicable PTM's. Information in this manual is based on the current edition of PennDOT Specification Publication 408, including all of the latest revisions as of print date, the most recent applicable PTM's as issued in PennDOT Publication 19 and current PennDOT policy as issued in Publication 2 Project Office Manual. It is the responsibility of the student to obtain the most recent versions of all applicable PTM, AASHTO and ASTM Test Methods referenced in this manual for future use.

Complete details concerning the PennDOT Concrete Certification Program are outlined in PennDOT Publication 536, Concrete Technician Certification Program. Questions concerning the PennDOT Concrete Certification Program can be directed to the Construction Quality Assurance Division Chief, Bureau of Construction and Materials at 717- 787- 5610.

Exam Grades are immediately available at the conclusion of the exam and are posted online at the NECEPT Website below within a two to three week period following the conclusion of the course.

Exam Grades are listed by the Class ID Number. Exam Grades can be viewed by selecting the appropriate Course ID Number under Concrete Field Testing Technician. The Exam Grades are then listed by your assigned NECEPT Number.

<http://www.superpave.psu.edu/Training/Exam-Grades/Exam-Grades.aspx>

The screenshot shows the NECEPT website interface. At the top, there is a navigation bar with the Penn State College of Engineering logo and the text 'NORTHEAST CENTER OF EXCELLENCE FOR PAVEMENT TECHNOLOGY'. Below this are navigation tabs for TRAINING, NEAUPG, RESEARCH, ABOUT NECEPT, and USEFUL LINKS. A search box is also present. The main content area features a sidebar on the left with the heading 'Don't Know Your Password?' and a link to 'MY NECEPT LOGIN'. The main heading is 'Exam Grades'. The text explains that users must sign in to their NECEPT account to view exam results. It also states that grades will be posted as quickly as possible, but may take up to two weeks. Certificates and cards will be mailed to the address on file. If users cannot find their NECEPT ID number, they are advised to contact NECEPT by phone or email. A table lists the minimum passing grades for various certification types: Aggregate Technician (70%), Asphalt Field Technician (75%), Asphalt Level 1 Plant Technician (75%), Superpave Volumetric Mix Design Workshop (75% Quiz Grade), and Concrete Field Testing Technician (75%). A 'Retests' section notes that one retest is available for most certifications. The footer of the page contains a bolded instruction to note the Course ID and NECEPT ID numbers, and a note that the passing grade for all concrete courses is 75%.

Don't Know Your Password?
Go to [MY NECEPT LOGIN](#) to retrieve your password information.

Exam Grades

Please sign-in to your NECEPT account at [MY NECEPT LOGIN](#) to view your exam results. Your NECEPT ID number and password are required.

Grades will be posted as quickly as possible. There may be times when it may require up to approximately two weeks after the course date for grades to be posted to your NECEPT account.

Certificates and cards will be mailed to the address that is listed in your account. Please keep your contact information updated through [MY NECEPT LOGIN](#).

If you are unable to locate your NECEPT ID number or do not receive your card within three weeks of your results being posted to your NECEPT account, please contact NECEPT by calling 1-814-863-1293 or emailing superpave@psu.edu.

The minimum Passing Grade for each certification is listed below:

Certification Type	Passing Grade
Aggregate Technician	70%
Asphalt Field Technician	75%
Asphalt Level 1 Plant Technician	75%
Superpave Volumetric Mix Design Workshop	75% (Quiz Grade)
Concrete Field Testing Technician	75%

Retests

One retest is available for most certifications. Please see the Retest information for your certification under the "[Training](#)" tab for details.

Please make note of your Course ID Number and the NECEPT ID Number that was assigned to you.

Note: The passing grade for all Concrete courses is 75%.

PennDOT Publication 536, Concrete Technician Certification Program is included in Appendix I of this manual and provides information regarding retest procedures for the PENNDOT Certified Concrete Field Technician exam.

I. QUALITY CONTROL PRACTICES

The Contractor must provide and maintain a quality control system that assures all materials and products submitted to the Department for acceptance are in compliance with all specification requirements. Quality cannot be tested or inspected into a product; it must be “built in.” Strict adherence to AASHTO and/or PTM procedures cannot guarantee that all ready mixed concrete will be delivered to the jobsite within specification requirements, but it helps eliminate many common problems and minimizes the possibilities for concrete failure. In addition to the specifications, AASHTO, and the PTM’s there are certain acceptable practices regarding the proper mixing, placement, testing and curing of ready mixed concrete which can have a beneficial effect on the concrete. This section will address several of these common practices. The most important features of a good quality control plan addresses actions needed to keep the process in control, provides a quick determination when the process goes out of control, and provides an adequate response to bring the process back in control without harming the final product.

I.a. QUALITY CONTROL PLANS

The contractor must provide a quality control plan to the Department at least three weeks before the first concrete placement as per Publication 408 Section 704.1(d)1.a. It is in everyone’s best interest that the QC plan be comprehensive and cover all aspects of the sampling and testing and field operations prior to the start of a concrete placement rather than waiting until the concrete arrives on the project and problems are encountered. The Department has developed Form CS-704 to provide minimum requirements necessary for a quality placement operation. However, the Form CS-704 is not to be submitted as the comprehensive QC Plan required for constructing concrete pavements to assure compliance with the requirements of Pub. 408 Section 501. This will be addressed later in the course.

Many of the topics that follow should be addressed in the contractor's QC plan in order to provide a timely resolution to problems that may be encountered during a concrete placement. The contractor’s technician and the Department representative should both be familiar with all aspects of the QC plan. A copy of Form CS-704 is included in this manual.

General Note: The specifications are very clear in expressing that no “out-of- spec” material will knowingly be incorporated into the work. Sound quality control practices and procedures should address this issue either directly or indirectly. While awaiting results of material tests for acceptance or control, sound engineering judgment should be exercised when allowing a placement to continue during the testing or whether the placement should be halted pending test results.

It is important that action points are addressed in the quality control plan as outlined on Form CS-704. The action points should be within the specification range and not at the specification limits. Action points must be at an appropriate measure with the understanding the supplier has already batched concrete without adjustments. When test results meet or exceed the action points, initiate corrective measures by contacting the supplier and/or performing additional QC testing until material control is re-established.



MINIMUM QUALITY CONTROL PLAN FOR FIELD PLACEMENT CONCRETE OPERATIONS

(Attach additional sheets as necessary)

State Route (SR): _____ Section: _____ County: _____ ECMS#: _____

Prime/Sub Contractor: _____

A ORGANIZATIONAL CHART

PERSONNEL	FULL NAME	RESPONSIBILITIES
1. Superintendent		Oversees concrete operations.
2. Concrete Foreperson		Oversees placement of material and related operations.
3a. Certified Field Technician		Performs field tests and sampling and acts as contact person to PennDOT.
	PennDOT Certification No.:	Expiration Date:
3b. Technician-in-Training		Date Issued:
4. Certified Finishers		Certification No.: Expiration Date:
		Certification No.: Expiration Date:
		Certification No.: Expiration Date:
		Certification No.: Expiration Date:
		Certification No.: Expiration Date:

Note: Problems related to concrete material, placement operations, and testing shall be directed to the appropriate personnel listed above.

B MIXING AND DELIVERY

- Concrete shall be supplied from a current PennDOT approved concrete plant listed in Bulletin 42.
- Two-way communications shall be maintained between the concrete plant and the work site.
 - A plant delivery slip signed by the plant technician and containing the information specified in Publication 408 shall be supplied for each truck.

C MATERIAL CONTROL

Material control is considered established when all tests results of concrete temperature, air, and slump of three consecutive trucks are determined to be within the established action points. **If a test exceeds the upper or lower action points the testing frequency shall be increased to every truck until material control is reestablished and the plant technician shall be notified.**

**LIST DESIGNS AND SLUMP REQUIREMENTS
(Attach additional sheets as necessary)**

Concrete Supplier Code	JMF Number and Year	Structural Element Being Placed	Class of Concrete and Slump Upper Limit (Pub 408)	Selected Target Slump Value	Target Range [+/- 1 1/2" max. from the selected target slump value]	Action Points [May not be < 1/2" from target range values]

Note: Target range not to exceed upper slump limit. More stringent action points may be specified if desired.

TESTING REQUIREMENTS

1. Temperature (ASTM C1064)

Shall be performed every time air and slump tests are performed. If the action points shown below are reached, the plant shall be contacted so corrective action can be taken. Additional tests shall be performed as specified in Publication 408. Concrete that does not meet the temperature specification requirements shall not be incorporated.

Concrete Temperature Spec. Limits	_____ and _____
Concrete Temperature Spec. Limits (Concrete Deck Placement)	_____ and _____
Concrete Temperature Action Points	_____ and _____
Concrete Temperature Action Points (Concrete Deck Placement)	_____ and _____

TESTING REQUIREMENTS (CONTINUED)

2. Slump tests (AASHTO T119)

Shall be performed on the first three consecutive trucks and until material control is established. Additional tests shall be performed as specified in Publication 408. If the slump upper limit is exceeded, the contractors' technician SHALL reject the truck.

If the District permits the addition of water to adjust for low slump concrete, specify the controls and procedure for adding the water: (No water may be added to AAAP. Attach a comprehensive plan if water reducer is to be added on site.)

Slump specification limits and actions points are indicated in "**LIST DESIGNS AND SLUMP REQUIREMENTS**" shown on previous page.

3. Air test (AASHTO T152 or T196)

Shall be performed on the first three consecutive trucks and until Material control is established. Additional tests shall be performed as specified in Publication 408.

Concrete Air Content Spec. Limits	_____ % and _____ %
Concrete Air Content Spec. Limits (AAAP and Paving)	_____ % and _____ %
Concrete Air content Action Points	_____ % and _____ %
Concrete Air Content Action Points (AAAP and Paving)	_____ % and _____ %

- Low air content material may be remixed at mixing speed and retested. (1 time only, not to exceed the maximum allowed time or 300 revolutions)
- High air content material may be allowed to mix at agitating revolutions for a period of time and re-tested. (1 time only, not to exceed the maximum allowed time or 300 revolutions)
- Trucks with high air content material may be pulled aside with the barrel stopped, not to exceed 45 minutes, as specified in Pub. 408, Section 704.2(c). Prior to retest, the concrete is agitated for at least 20 revolutions. (1 time only, not to exceed the maximum allowed time or 300 revolutions)
- Consult with ready-mix supplier before any of the above field adjustments are attempted. Field adjustments by adding water are not permitted to adjust plastic air content.(AASHTO M 157)

4. List Concrete Testing Equipment (Attach additional sheets as necessary)

- All air meters will be calibrated prior to use and at least once every 2 weeks thereafter in the presence of the Inspector.

D CONCRETE CYLINDERS**1. Number of Concrete Cylinders**

The following number of concrete cylinders shall be molded and cured according to PTM No. 611 for testing purposes. Cylinders shall be identified on the outside of the mold using indelible ink and shall be capped with domed lids:

- _____ 3-Day Quality Control compressive strength
- _____ 7-Day Quality Control compressive strength
- _____ 14-Day Quality Control compressive strength (AAAP)
- _____ Cylinders for form removal strength (Specify:_____)
- _____ Cylinders for loading strength (Specify:_____)
- _____ 28-Day Quality Control compressive strength
- _____ 28-Day Acceptance compressive strength
- _____ 56-Day Quality Control compressive strength (AAAP and Prevention Level Z mixes)
- _____ 56-Day Acceptance compressive strength (AAAP and Prevention Level Z mixes)

The number of Verification cylinders and Quality Assurance cylinders molded shall be as specified in Publication 408 and molded and cured according to PTM No. 611.

2. Curing Concrete Cylinders (Attach additional sheets as necessary)

Curing and care of the concrete cylinders shall be the responsibility of the contractor.

FIRST 24 HOURS OF CURING:

- Cylinders shall be moved within 15 minutes of molding to the curing location.
- Maintain initial curing temperature for all normal strength concrete cylinders 60°F and 80°F.
- Describe method of curing for first 24-hours for each type of cylinder:

AFTER 24 HOURS OF CURING:

- Cylinders shall be stripped from the molds and the original identification shall be transferred from the cylinder mold onto the cylinder using indelible ink.
- Acceptance cylinders will be cured in a lime bath with a temperature of 73 +/- 3 °F.
- Describe method of curing after 24 hours for each type of cylinder: (Attach addendum for Cool and Cold Weather Curing as necessary):

CYLINDER TRANSPORTATION AND HANDLING

- Describe the method of transportation and handling.

- Specify the location of the concrete break machine.

E FIELD PLACEMENT WORKFORCE AND EQUIPMENT

List workforce, equipment, and method of placement (bucket, pump etc.) for each structural element.
(Attach additional sheets as necessary)

Submitted By: _____ Date: _____

Supplier Reviewed By: _____ Date: _____

Department Reviewed By: _____ Date: _____

I.b. Transporting, Mixing and Placing Concrete

1. Definitions

Truck Mixed Concrete – Truck mixing is a process by which previously proportioned concrete materials from a batch plant are charged into a mixer truck for mixing and delivery to the job site.

Central Mixed Concrete – Concrete mixed completely in a stationary mixer and then transferred to another piece of equipment for delivery. This transporting equipment can be a mixer truck operating as an agitator, or it may be an open top truck body with or without an agitator.

Counter – A mechanical or electronic counting device, usually mounted to the forward drum support that counts total and mixing revolutions of the truck drum. The device will also have a reset control to return counter to zero.

2. Mixing Concrete for Placement

Truck Mixing – After all raw materials have been loaded into the truck drum at the plant, mix for not less than 70 nor more than 125 truck drum revolutions at *mixing speed* of not less than 6 truck-drum rpm nor more than 18 truck-drum rpm.

Central Mixing – Mixing time shall be counted from the time all the raw materials are in the drum. Mixing time required should be based upon ability of the mixer to produce uniform concrete throughout the batch and from batch to batch. Initial mixing times are specified in Section 704.2(c).

3. Transporting Concrete to the Project

If using mixer or agitating trucks to transport concrete to the project, mix concrete in route to the project at *agitating speed* (not less than 2 truck-drum rpm or more than 6 truck-drum rpm). At the project, agitate the concrete for at least 20 revolutions prior to placing the concrete. Do not place concrete that has exceeded 45 minutes without agitation.

4. Temperature Limitation for Concrete Placement

Maintain concrete temperatures at placement between 50°F and 90°F except for bridge decks, which shall be between 50°F and 80°F. For accelerated concrete placements, maintain the concrete temperature between 50°F and 100°F.

Temperature limitations may vary for special application concrete mixes. Refer to the contract special provisions for details.

5. Discharge Times for Concrete Placement

Discharge of the concrete shall be completed within 1½ hours from the completion of mixing if the concrete temperature is less than 80°F and within 1 hour from the completion of mixing if the concrete temperature is 80°F or above and no approved set retarding admixture was included in the mix.

If an approved set retarding admixture was dosed in accordance to the manufacturer's recommendations into the mix an additional 30 minutes of discharge time is added. This would provide 2 hours when the concrete temperature is less than 80°F and 1½ hours when the concrete is 80°F or above

The concrete must always be discharged before 300 truck-drum revolutions have occurred on the truck mixer.

If non-agitating vehicles are used to transport concrete to the project, the concrete must be completely discharged in 45 minutes.

6. Evaporation Rate for Bridge Deck Concrete

Provide the necessary equipment and determine the evaporation rate before starting a deck placement and every hour during the placement.

Do not exceed an evaporation rate of 0.06 pounds per square foot per hour.

The evaporation rate for exposed finished concrete may be determined by applications, spreadsheets, equipment, etc.

Have readily available at the bridge deck placement site, all remediation equipment and procedures as submitted and approved at the deck pre-placement meeting before starting the placement.

If the value is exceeded, stop concrete placement until protective measures are taken to reduce the values to an acceptable level.

I.c. Communication Between Jobsite and Plant

Communication between the Concrete Field Testing Technician and the concrete plant is essential for maintaining quality control on the project. Reporting of field test results will allow the ready-mix supplier to make necessary corrections or adjustments to the mix to ensure compliance with specification. A lag in the reporting of field test results to the respective supplier's plant could result in delays in making necessary batching adjustments. Results of necessary batching adjustments may not be immediately realized in the field due to loads in transit. As a result, one or more additional loads may require the judgment of the responsible Department and Contractor field personnel to adjust the mix at the jobsite.

Prior to shipping concrete, a plan of communication should be established. Part of this plan should be the development of action points for each variable in the concrete (e.g. a drop-in air content to an agreed point). Action points are addressed in Publication 408, Section 704.1(d)1.a. Information to be communicated should include all test results, changes in delivery system, or other jobsite variances, which will be the cause for making adjustments to ensure the concrete shipments remain in specification.

It should be understood that variables such as haul time, temperature, mix composition, etc. may require concrete plant targets for air and slump to sometimes be in excess of the point of placement/acceptance specifications.

It is well established that concrete in transit will show changes in both slump and/or air. Therefore, this average cannot be determined adequately until results from the jobsite are conveyed back to the plant. This information must continue until placement is completed.

Methods of communication may vary but need to be clearly established.

Two-way radio – Common in most ready-mix trucks for communication back to the plant.

Phones – Cellular or Regular

Many factors on the jobsite may also require communication back to the plant:

Equipment breakdowns requiring a change in shipments

Weather changes at the site versus plant, (e.g. thundershowers)

Medical emergencies

New/different test equipment

In general, communication between the jobsite and the plant can minimize problems on both ends of the project and ensure a quality product as an end result.

I.d. Common Sense Quality Control in the Field

Quality control test frequencies should be clearly established in the Contractor's Quality Control Plan. Tests should be performed on each load until material control (uniformity) has been established. Material control is understood to be a range of results that is within defined action points established in the quality control plan. Material control is established when all test results of concrete slump, air, and temperature on 3 consecutive trucks are within the established action points as defined in Section 704.1(d)4.a.

The frequency of QC testing can be diminished to once every 50 cubic yards as the job progresses, as long as the material is within specification requirements and is within the established action points. Once material control has been established, Section 501 permits QC test frequencies for concrete paving operations may be reduced to a minimum of one set of tests every 50 cubic yards or 30 minutes, whichever is greater.

Tests are to be performed from concrete sampled per PTM 601 and AASHTO R-60. However, time may be the greatest variable to consistency. The concrete must be placed as quickly as possible to maintain the most uniform material.

There are several steps that may be taken to correct variations when material arrives at the jobsite and does not meet specification requirements. All mix adjustments or corrections that are proposed at the jobsite must be clearly detailed in the contractor's quality control plan. However, at no time may the maximum time or revolution limits be exceeded.

It is important to consult with the ready-mix plant and contractor representative prior to attempting any adjustment of the mix at the jobsite. Modifying the material in the field is at the risk of the contractor/producer, and it is their determination to do so when permitted by the Department.

I.e. 408/704 Slump Quality Control Requirements

1. Slump Specification

704.1(d)4. QC Testing. Perform QC testing according to the reviewed QC Plan and as follows:

4.a QC Sampling and Testing of Plastic Concrete. Select an appropriate slump value that will provide a workable mix for the construction element. The Contractor's technician must have a copy of the Department reviewed QC Plan in their possession during testing and must be aware of the target slump for the structural element being placed. Do not exceed the following slump upper limits:

Type of Mix	Slump Upper Limit
<i>without water reducing admixtures</i>	5 inches
<i>with water reducing admixtures</i>	6 1/2 inches
<i>with high range water reducing admixtures (superplasticizers)</i>	8 inches
<i>mixes specified in Section 704.1(h)</i> <i>(except tremie concrete as specified in Section 1001.2(j))</i>	2 1/2 inches
<i>AAAP (regardless of admixtures used)</i>	5 1/2 inches
<i>AAAP LW (regardless of admixtures used)</i>	6 Inches

Perform plastic concrete slump, air, density (for AAAP LW and AA LW) and temperature tests on the first three consecutive trucks at the beginning of concrete placement operations or after a significant stoppage such as plant or equipment breakdown to determine if material control has been established. Material control is established when all test results of concrete slump, air, and temperature for three consecutive trucks are determined to be within the established action points. Obtain samples of fresh concrete according to PTM No. 601. Perform slump tests according to AASHTO T 119, air content tests according to AASHTO T 152 (DO NOT APPLY AN AGGREGATE CORRECTION FACTOR) or T 196 (DO NOT APPLY AN AGGREGATE CORRECTION FACTOR) (AASHTO T196 for AAAP LW and AA LW), temperature tests according to ASTM C1064, and density testing according to AASHTO T 121 (for AAAP LW and AA LW) Report test data to the concrete technician promptly in order to facilitate necessary changes. Continue testing consecutive trucks until material control is established. Once material control is established, the frequency of testing may be reduced to a minimum of one test per 50 cubic yards. Select concrete batches for sampling according to the reviewed QC Plan or as directed by the Inspector. Notify the Inspector if sampling and QC testing are to be performed. The Inspector will witness the sampling and QC testing. If a QC test fails to conform to the specified requirements or exceeds the upper or lower action points included in the reviewed QC Plan, increase the testing frequency to every truck until material control has been reestablished.

Maintain the cement concrete consistency within 1 1/2 inches of the selected target slump value (target range). If the upper slump limit is exceeded on any slump test, the Contractor's technician shall reject the cement concrete. If any slump test result falls outside the target range and has not exceeded the upper limit, immediately perform the air content and temperature tests. If the air content and concrete temperature is within the specified limits, the Contractor may incorporate the material into the work provided a full set of quality control and acceptance cylinders are molded in addition to the cylinders made for the originally selected PTM No. 1 sample location, for compressive strength testing according to PTM No. 611 and PTM No. 604. If one or more truckloads of cement concrete exceeds the slump target range, make additional quality control and acceptance cylinders from each truck. Use the lowest compressive strength cylinders for acceptance of the lot.

Do not incorporate concrete into the work that does not conform to the specified requirements.

2. Slump Specification Summary

The Contractor selects an appropriate slump value that will provide a workable mix for each construction element. Communication between the contractor and producer is required to establish these values. This is presented in the contractor's Quality Control plan for the District's review.

The Contractor's acceptance criteria for slump is a maximum $\pm 1.5''$ from the selected target value. Consistency for slump, air content, and temperature must be established as per QC plan requirements. Maintain the slump within the target range.

If the upper slump limit established by specification is exceeded (5"; 5.5"; 6.5"; 8"; 2.5"), the contractor's technician shall reject the concrete. One retest for slump will be allowed to verify the rejection; however, no additional handling of the mix is permitted.

If the slump falls outside the contractor's established target range but has not exceeded the upper slump limit, and the air content and temperature are within specified limits, the contractor may incorporate the material into the work provided a full set of quality control and acceptance cylinders are molded in addition to the set of cylinders at the originally selected acceptance sample location. The lowest compressive strength cylinders will be used for acceptance of the lot.

If the slump falls below the contractors established target range, it is obviously below the upper slump limit. While the same conditions for use apply as noted above, there are obvious workability issues with a low slump that is below the desired target range. Typically, this concrete would be rejected by the contractor for being outside the established target range. However, if incorporated into the work, a full set of quality control and acceptance cylinders are to be molded (after the addition of water) in addition to the set of cylinders at the originally selected acceptance sample location whether the addition of water at the jobsite is permitted by the District, or not. The lowest compressive strength cylinders will be used for acceptance of the lot.

Do not incorporate concrete into the work that does not meet specification requirements.

I.f. Field Adjustments of Concrete Mixes

The following is the Department's policy for making field adjustments of concrete mixes to improve the workability, by adding water at the jobsite.

The decision to allow the addition of water at the jobsite ultimately rests with each individual PennDOT District. Where permitted, the process must be well-defined in the contractor's quality control plan. At no time should water be deliberately withheld from the mix at the source during the initial batching of the mix. The producer must be informed immediately whenever field adjustments for workability are required so the necessary adjustments can be made to the mix at the plant under more controlled conditions. The intent of this policy is to allow for corrections at the beginning of a placement or for unforeseen circumstances that may occur during a placement and not as an ongoing means of controlling the concrete workability at the jobsite.

****Note: This policy is not intended for use with Bridge Decks. For Bridge Decks, do not add water to concrete in the field. Adjustment of slump may be allowed by adding water reducer at the job site if a comprehensive procedure detailed in the QC plan has been submitted and accepted by the DME/DMM for this purpose as specified in Publication 408, Section 1001.3(h).*

REPLACES B.6.17	PENNSYLVANIA DEPARTMENT OF TRANSPORTATION	PART B	SECTION 6	PAGE 17-1
DATED 04/01/2014	PROJECT OFFICE MANUAL	DATE April 1, 2020		
SUBJECT FIELD ADJUSTMENT OF CONCRETE MIXES				

As specified in Publication 408, Section 704, water may only be added to concrete mixes from a concrete plant's water measuring system. However, due to errors that may occur in the moisture content of the aggregates at the start of a batching operation or due to unforeseen circumstances at or in route to a jobsite, the need may arise to add water to correct the slump of the mix at the project site.

The decision to add water to a mix at a project site must be made by the contractor's PennDOT certified field testing technician. The Department Representative will determine the maximum amount of water that can be added. The addition of water must be done under the supervision of the Department Representative.

Water may only be added to trucks at the start of the batching operation or due to unforeseen circumstances that may occur during the concrete placement. The producer should be informed immediately whenever field adjustments are required. Allow the producer sufficient time to make necessary adjustments at the plant. Concrete shall be mixed to the approved proportions in the design. Water shall not be withheld deliberately.

The addition of water is limited to 1 gallon per cubic yard of concrete in the truck, and the total water in the mix cannot exceed the maximum water/cement ratio of the trial mix on the design. The addition of water is only permitted to be added at the beginning of the full load after the initial testing is complete. All mix adjustments must be recorded in the iPad App Mobile Construction Concrete Inspectors Diary (MCCID). After the additional water has been loaded into the mixing drum, the drum must be turned an additional 30 revolutions or more at mixing speed. The total number of mixing revolutions cannot exceed 300. The concrete must be resampled and retested for slump, temperature, and plastic air content and meet the specification requirements prior to incorporating into the work. In addition, compressive strength cylinders must be molded from the retested material.

Transit truck mixers must be inspected annually, including the truck-mounted water systems, and documentation (See Form [CS-4337](#)) must be presented to the Inspector prior to adjusting the mix.

Specific details regarding the field adjustment of concrete mixes must be included in the contractor's concrete quality control plan. Districts that do not currently permit the field adjustment of concrete mixes may continue this policy.

This policy is not intended for use with Bridge Decks. For Bridge Decks, do not add water to concrete in the field. Adjustment of slump may be allowed by adding water reducer at the job site if a comprehensive procedure detailed in the QC plan has been submitted and accepted by the DME/DMM for this purpose as specified in Publication 408, Section 1001.3(h).

I.g. Slump Adjustments at the Jobsite

1. Low Slump

Low slump concrete may be the result of inadequately mixed materials. Low slump materials should be re-mixed at mixing speed to ensure all materials are properly mixed, and then re-tested.

If approved by the District Materials Engineer, water may be added on the jobsite at the rate of one (1) gallon per cubic yard of concrete in the truck, provided the additional water does not exceed the maximum water/cement ratio of the trial mix on the design. The addition of water, where permitted must be from a metered water system. After the additional water has been added into the mixing drum, the drum must be turned an additional 30 revolutions or more at mixing speed. The total number of truck-drum revolutions cannot exceed 300. The concrete must then be re-sampled and re-tested for slump, temperature and plastic air content. A complete set of quality control and acceptance compressive strength cylinders must be molded from the new sample. All mix adjustments must be recorded in the Concrete Inspectors Daily Record Book or MCCID App. **SPECIFIC DETAILS REGARDING THE FIELD ADJUSTMENT OF CONCRETE MIXES MUST BE INCLUDED IN THE CONTRACTOR'S QUALITY CONTROL PLAN.**

If neither of these procedures brings the material into compliance of the specification, it shall be rejected by the Contractors technician for use on the project.

***NOTE:** The following “rule of thumb” applies when making adjustments to the mix for workability. A slump change of a ½ inch produces an approximate 1.0 % change in the plastic air content. Therefore, when the slump increases, so does the air content and as the slump decreases, so does the air content. This is not always the case, but is generally true depending on the admixtures in the mix.*

2. High Slump

Per Pub. 408 Section 704.1(d)4.a , concrete that arrives on the jobsite with a slump that exceeds the target range of the Quality Control Plan, but **Does NOT Exceed the Maximum Slump as defined in the Specification**, may be placed without any additional handling provided the plastic air content and temperature meet specification requirements. A full set of quality control and acceptance cylinders must be molded from the sample. These cylinders are in addition to the originally specified acceptance cylinders molded for compressive strength. Additional handling and retesting to bring the concrete into the target slump range does not eliminate the need to mold the additional cylinders. The cylinders with the lowest compressive strength will be used as the acceptance cylinders for that lot.

Concrete delivered to the jobsite with a slump that exceeds the PennDOT specification upper limit will be rejected by the Contractors technician. One retest for slump will be allowed to verify the rejection, however, no additional handling of the mix is permitted.

I.h. Air Content Adjustments at the Jobsite

Plastic air content is generally accepted when in the following ranges: $6.0\% \pm 1.5\%$ (4.5% to 7.5%) in most cases and $7.0\% \pm 1.5\%$ (5.5% to 8.5%) for AAAP and AA(pave) mixes. (Please reference Special Provisions in the Contract for exceptions). One retest of the material will be permitted before rejecting the concrete for use on the project.

1. Low Air Content

Low air content concrete may be re-mixed at mixing speed and re-tested for acceptance.

Concrete for use on PennDOT projects is produced in accordance with AASHTO M-157, Standard Specification for Ready-Mixed Concrete. **Field adjustments of mixes by adding water are NOT permitted to adjust for plastic air content according to this standard.**

2. High Air Content

High air content concrete may be allowed to mix on agitating revolutions for a period of time and then be re-tested.

The truck may be pulled aside with the barrel stopped, not to exceed 45 minutes, per Publication 408, Section 704.2(c). Prior to retesting, agitate the concrete for at least 20 revolutions at the end of non-agitation. Do not use concrete that has exceeded 45 minutes without agitation. The concrete must be discharged within 1.5 hours (or 1 hour) after completion of initial mixing when no approved set retarding admixture was included in the mix.

If neither of these procedures brings the material into compliance of the specification, it shall be rejected.

3. Commentary

The type of air entraining agent can have a major effect on the ability to entrain and hold air in concrete. These are basically two types of air entraining agents currently being used by the industry:

- Natural – made from vinsol resin from the pulp industry
- Synthetic – made from synthetic (manufactured) surfactants, such as detergents.

While both can be used to generate microscopic air bubbles in concrete, the choice is usually based on the best uniformity in the plastic concrete, both in generating air and retaining the air content in transit. Remixing air-entrained concrete should be done with caution, as too much mixing can cause too high an air, which can result in strength loss.

Review Questions

I. Quality Control Practices

1. Upon arrival at a jobsite, concrete from a revolving drum mixer must be agitated for at least _____ revolutions prior to placing the concrete.
2. Concrete temperature for a bridge deck placement must be between _____ °F and _____ °F.
3. The maximum allowable slump for a mix with a high range water reducing admixture is _____ inches.
4. For an accelerated concrete placement, the concrete temperature is to be maintained between _____ °F and _____ °F.
5. The contractor's target range for slump is _____ inches from the selected target value.
6. The contractor must provide a quality control plan as outlined on Form CS-704 to the Department at least 3 weeks prior to the first concrete placement. True / False
7. Central-mixed concrete delivered in non-agitating vehicles must be completely discharged in _____ minutes.
8. If out-of-specification concrete is not brought back into specification, it should be rejected by the _____.
9. The Department permits water to be added to the mix at the jobsite to increase the air content of the mix. True / False
10. If the mix arrives with a high plastic air content, the load must be immediately rejected. True / False
11. Where permitted by the District, water may be added at the jobsite to increase the slump for workability at a rate of _____ gal/CY, not to exceed the maximum W/C ratio of the trial mix on the design.
12. If a slump test result for a mix with a water reducer exceeds the contractor's specified target range for acceptance but is less than the 6 ½ inch maximum permitted by specification, the concrete must be rejected. True / False
13. Truck-mixed concrete must be discharged before the drum has revolved _____ revolutions.

Review Questions – cont'd

I. Quality Control Practices

14. A full set of QC and AT cylinders must be made if a contractor elects to use concrete with a slump test result that is outside the contractor's specified target range for acceptance but is less than the maximum allowed by the specification. True /False
15. The contractor submits a _____ in order to provide timely resolution to problems encountered during a concrete placement.
16. During a bridge deck placement, if the evaporation rate exceeds _____ pounds per square foot per hour, the concrete placement should be stopped until protective measures are taken as specified in the Quality Control Plan.
17. A 10 CY load of concrete arrives at a jobsite. The slump is within the contractor's selected target range and the plastic air content is tested and is 3.9%. How many gal/CY of water may be added to increase the air content to 4.5%? _____.
18. In general, communication between the jobsite and the plant can minimize problems on both ends of the project and ensure a quality product as an end result. True / False
19. Material control (uniformity) is established when all test results of concrete slump, air, and temperature on _____ consecutive trucks are within the established action points.
20. For Section 704 concrete, the frequency of QC testing can be reduced to a minimum of once every _____ cubic yard as the placement progresses as long as the material is within specification requirements and established action points.

II. PROJECT DOCUMENTATION

At the start of any concrete operation and prior to any field adjustment of concrete, the Concrete Field Testing Technician must have the following information in hand along with the approved Quality Control Plan:

- TR-4221A Concrete Mix Design that has been reviewed and approved by the DME or DMM for the class of concrete being placed.
- CS-4220 Batcher Mixer Slip
- Concrete Delivery Ticket

II.a. TR-4221A Concrete Mix Design

The front sheet of the Master Concrete Mix Design is the only sheet that needs to be submitted to a project. **The Mix Design must be reviewed and approved by the DME prior to use.** The Concrete Mix Design Form was revised in 2009 to include an additional coarse aggregate and for the addition of minimum Manufacturer's dosage rates for the retarder, water reducer and high range water reducer. The Concrete Mix Design Form requires the following criteria for those admixture dosage rates:

When a retarder (RE) admixture is used in concrete 80° F and over or in hot weather, the Manufacturer's Minimum recommended dosage rate for retarder (RE) admixture must be used to get 90 minutes of mixing time. When using a water reducer (WR) admixture, it must be used at the manufacturer's minimum dosage rate to use the maximum 6 1/2" slump spec per 704.1(d)4.a. When using a high range water reducer (HRWR) admixture, it must be used at the manufacturer's minimum dosage rate to use the maximum 8" slump spec per 704.1(d)4.a. Any additional admixtures utilized to enhance the concrete performance may be below the manufacturer's minimum recommended dosage rate.

The Concrete Field Testing Technician should be aware of the minimum admixture dosages on the mix design and their effect on the maximum mixing time and the maximum slump allowed for that mix design.

A sample of a completed TR-4221A for a project is provided on the next page. All header information pertaining to the identification of the mix must be completed.

The material, admixture, and strength data must also be completed.

The maximum W/C ratio for this mix is represented by the trial mix which is labeled as the Max W/C on the Concrete Mix Design Form. This represents the maximum water that may be used in this mix.

The adjusted mixes should represent a “step-down” from the maximum W/C ratio. The W/C step down is usually in 0.02 or 0.01 intervals.

The technician responsible for the development of the mix design and the DME's signature must be included as well as any intermediate approvals, reviews, or submittals.

<p>TR-4221 (12-15)</p>  <p>pennsylvania DEPARTMENT OF TRANSPORTATION</p>	Concrete Mix Design Form		Producer	Ready Mix Concrete Supply Inc
			Location	
			Contractor	
			Sec/Segment	
			SR/WO	
			Material Class	AA
			Mix Identifier	
			Structure Class	
			ECMS No./PO No.	
			JMF Status	Approved
<p>Supplier Code RMC02A42</p> <p>JMF Year 2021</p>		<p>JMF No. 555</p> <p>Supplier/JMF/Design # (Opt.) </p>		

Material	Material Code	Material Class	Product Name	Producer Name	Supplier Code	Sp. Gr.	Abs	ASR	
Cement	276	1		PA Cement Company - Boomerville	PAC0 15	3.150	0.00		
Pozzolan	276	F		Ash Supply Company - Danville, PA	ASC0 15	2.400	0.00		
Coarse Aggregate	203	A57		Big Rocks Stone Company - Bedrock	BRS02A 14	2.600	0.46	0.02	
Fine Aggregate	207	A		Gravel Sand Company - Sand Lake	GSC02A14	2.588	1.16		
Water	420	WTRMIX	City of Pittsburgh	No Bulletin 15 Listing	NOBLT 15	1.000			
						Oz/cwt	Oz/yd	Mfg Dose/cwt	
								Min	Max
Admixture	403	AEA	AE120	Admixtures, Inc.	ADM0 15	1.00	5.88		
Admixture	403	WR	WR150	Admixtures, Inc.	ADM0 15	3.00	17.64	2.00	6.00
Admixture	403	RE	RE750	Admixtures, Inc.	ADM0 15	2.00	11.76	2.00	5.00

When RE admixture is used in concrete $\geq 80^{\circ}F$ or in hot weather, the manufacturer's minimum recommended dosage rate for RE admixture must be used to get 90 minutes of mixing time.

When using HRWR admixture, it must be used at the manufacturer's minimum dosage rate to use the maximum of 8" slump per 704.1(d)a.

When using a WR admixture, it must be used at manufacturer's minimum dosage rate to use the maximum of 61/2" slump spec per 704.1(d)4.a.

Any additional admixtures utilized to enhance the concrete performance may be below the manufacturer's minimum recommended usage rate.

RCP Coulombs 1547 Total admix water per cubic yard From trial mix dated 11/22/2005
 Microstrain Total admix solids per cubic yard 28/7 ratio from worksheet dated 11/22/2005
 Strength Data Based on Max W/C 0.470 28/7 day strength ratio (AAAP Only) % Air 6.00

F°c (Compressive Strength) PSI

7 Days	4,830 Avg PSI	14 Days	5,675 Avg PSI	28 Days	6,275 Avg PSI	56 Days	8,390 Avg PSI
--------	---------------	---------	---------------	---------	---------------	---------	---------------

	Material Code	Material Class	Supplier Code	Max W/C	Mix # 2	Mix # 3	Mix # 4	Mix # 5	
W/C Ratio by wt.				0.470	0.450	0.430	0.410	0.390	
Cement (lbs)	276	1	PAC0 15	500	500	500	500	500	
Pozzolan (lbs)	276	F	ASC0 15	88	88	88	88	88	
Total Cementitious (lbs)				588	588	588	588	588	
Coarse Agg. (lbs)	203	A57	BRS02A 14	1776	1776	1776	1776	1776	
Total Coarse Agg. (lbs)				1776	1776	1776	1776	1776	
Fine Agg. (lbs)	207	A	GSC02A14	1137	1168	1199	1230	1261	
Total Water (lbs)				276	265	253	241	229	
Admixture Water (lbs)									
Mix Water (lbs)				276	265	253	241	229	
Admixture Solids/yd (lbs)									
Total (lbs)				3777	3796	3816	3835	3855	
Unit Weight (lbs/cu.ft.)				139.88	140.60	141.32	142.04	142.76	
Coarse Agg. (cu.ft)				10.95	10.95	10.95	10.95	10.95	
Total Water (gal.)				33.2	31.8	30.4	28.9	27.5	
Mix Water (gal.)				33.2	31.8	30.4	28.9	27.5	

Designed By : W. Girad **Designed Date** : 5/5/21
Submitted By : J. Johnson **Submitted Date** : 5/6/21
District Approver : T. Jones, DME 11-0 **Approved Date** : 5/12/21

II.b. CS-4220 Batch-Mixer Slip

The Batch-Mixer slip is an important element in concrete control. It is prepared from information taken from the approved mix design and from the results of daily testing for surface moisture in the aggregates. These values are used to determine the amount of batched mix water to be added to each load. **The current version of the CS-4220 Batch-Mixer Slip is dated 10-21.**

Coarse and fine aggregate moisture is determined at the beginning of work and is recorded on the batcher mixer slip. This is delivered to the project with the first truck.

Moisture tests are required to be re-run every 4 hours during production. A new batcher-mixer slip is to be submitted every 4 hours to indicate the moisture tests were performed.

If field slump test values fluctuate or when placement problems occur that may be related to moisture/water in the mix, the plant should be informed, and it is recommended that the aggregate moisture is retested.

CS-4220 (10-21)



pennsylvania
DEPARTMENT OF TRANSPORTATION

Batcher Mixer Slip

Date 6/15/2021

Time 7:30

JMF Number 555-02

ECMS 67777

Contractor		Specialty Contractors, Inc.		Plant		Ready Mixed Concrete Supply, Inc.			
County		Allegheny		Project Location		S. Pittsburg (RMC02A42)			
S.R.	22	SECTION	A01	Design Gallons of Water Per Cubic Yard		31.80			
Class Concrete	AA	W/C Ratio	0.45	Design Gallons of Water - Admixture Water Per C.Y		31.80			
MATERIALS		SATURATED SURFACE DRY WEIGHT (lbs)		SURFACE MOISTURE (%)		SURFACE MOISTURE (lbs)		BATCH WEIGHT PER C.Y. (lbs)	
Cement		500				500			
SCM	Fly Ash	88				88			
SCM									
Sand		1168		4.10%	48	1216			
#57		1776		0.80%	14	1790			
Admixture [oz.]		Weight per gal						Admixture (Solids+Water) [lbs]	
Admixture [oz.]		Weight per gal						Admixture (Solids+Water) [lbs]	
Ice [lbs]								Ice-Water [lbs]	
Target Slump	4.00	Surface Moisture in Aggregates [lbs]			62.00				
% Air	6.0	Surface Moisture in Aggregates [gals]			7.44				
		Batched Mixing Water [gals]			24.36	203		Batched Mixing Water [lbs]	
PENNDOT Field Inspector (who gave release)				J.B. Inspector		Total Batch Weight		3797 lbs.	
PENNDOT Plant Inspector				D.M. Inspector		Batch Yield		27 cu. ft.	
Concrete Plant Technician				J. Technician		Wt/Cu.Ft.		140.63 lbs./cu.ft.	

II.c. Delivery Ticket Requirements 408/704.2(c)

For each truck, furnish a plant delivery slip signed at the plant by the technician or other designated responsible person. The following information is required, by specification, to be included on the delivery slip to the project:

- Contract number, complete state project number or purchase order number.
- The concrete plant supplier code.
- Method of concrete mixing (i.e., central or truck).
- Class of concrete, JMF number, and trial mix number (i.e., Max, #2, 3, etc.).
- Number of cubic yards.
- Time of completion of mixing.
- Truck number.
- Number of mixing revolutions, if applicable.
- Total amount of batch water used in each truck in pounds.
- The total weight in pounds of the total cementitious materials.
- The types of additives used in each truck (i.e., water reducer, AEA, retarder, etc.).



Ready Mixed Concrete Supply, Inc.
 P.O. Box 119 S. Pittsburgh, PA 15222
 Supplier Code RMC02A42

50555

MATERIALS TICKET

CUSTOMER NO.	P.O. NUMBER	PROJECT NUMBER	TRUCK NUMBER	TIME	DATE	TICKET NO.
111101		ECMS 67777	121	8:00 AM	6/15/2021	1-50555

SOLD TO	DELIVERED TO
SPECIALTY CONTRACTORS, INC.	SR 0022 SEC A01

PRODUCT CODE	PRODUCT DESCRIPTION	QUANTITY	UNIT OF MEAS	UNIT PRICE	AMOUNT
JMF - 555 - 2	PennDOT CLASS AA CONCRETE	10.00	CY		

LEAVE YARD	ON JOB	BEGIN POUR	USE OF CONCRETE		SUB-TOTAL
FINISH POUR	OFF JOB		TARGET SLUMP	WATER ADDED GALLONS	TAX
			3 1/2"		TOTAL MTL

I CERTIFY THAT THIS LOAD MEETS PennDOT 408 SPECIFICATIONS				METHOD OF CONCRETE MIXING	
X <u>J. TECHNIGIAN</u>				<input checked="" type="checkbox"/> TRUCK MIXED	<input type="checkbox"/> CENTRAL MIXED
No. 57	17730	LBS.			
SAND	12270	LBS.			
PORTLAND CEMENT	5000	LBS.			
FLY ASH	880	LBS.			
TOTAL BATCHWATER	1947	LBS.			
			WASH DOWN WATER = <i>10 gals</i>		
ADMIXTURE	AIR ENTRAINMENT	59	OZ.		
ADMIXTURE	WATER REDUCER	176	OZ.		
ADMIXTURE	RETARDER	118	OZ.		
ADMIXTURE			OZ.		
MIXING REVOLUTIONS		100	REVS		

Our drivers are instructed not to make deliveries beyond the curb line or existing road width unless directed by purchaser. We assume no liability for damage to property or for any instructions given to operators by purchaser, agent, owner, or contractor.

Cement Burn Warning: Caution: Avoid skin contact. May cause eye or skin injury. Contains Portland cement. Freshly mixed cement, mortar, or grout may cause skin injury. Take these precautions: Avoid all contact with eyes. Wear rubber boots and gloves and avoid prolonged contact directly with skin or through porous materials. In case of contact with skin or eyes, FLUSH THOROUGHLY WITH WATER. If irritation persists, get medical attention promptly. Keep children away. Read MSDS on reverse side.



I acknowledge the receipt of the material safety sheet information on the reverse side.
 CUST. SIGN. _____

II.d. Mobile Construction Concrete Inspectors Diary (MCCID) App & Concrete Inspectors Daily Record Book (CS-472)

MCCID App.



Concrete Book Inspections



ECMS User Name

Password

Login

Contact Information

Concrete Inspectors Daily Record Book

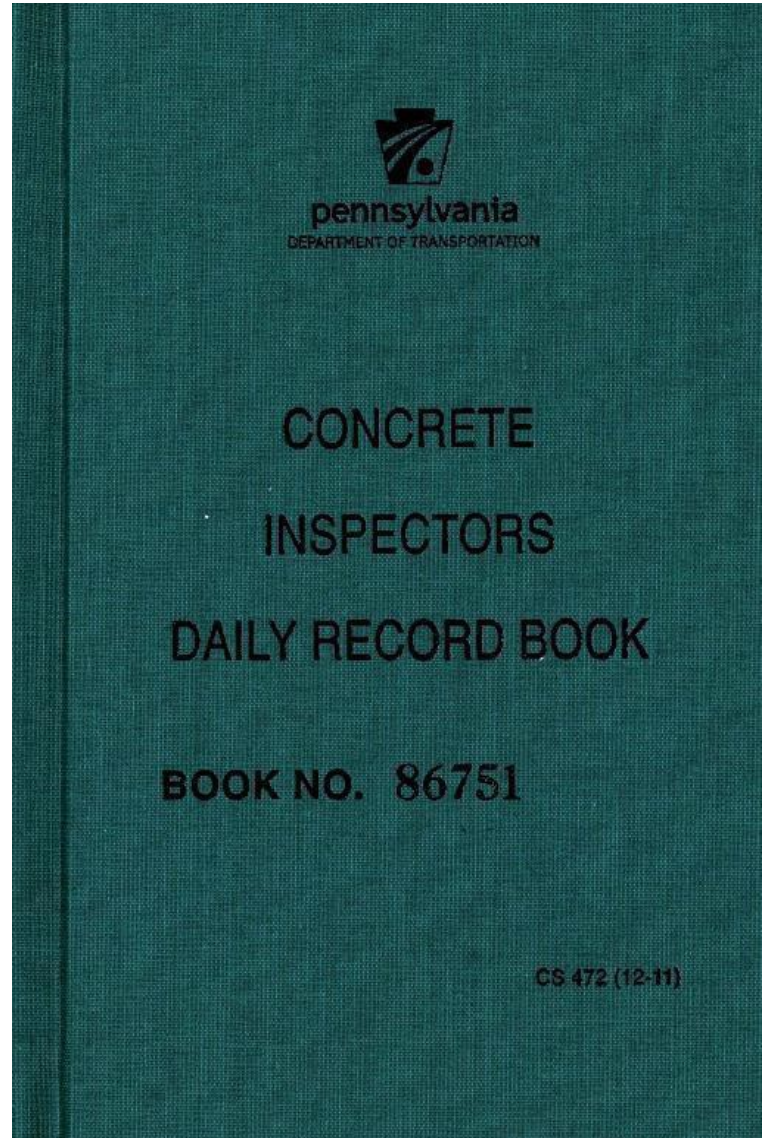

1. Field Concrete Test Documentation

***** Note that the MCCID App. should be the first option to be used in lieu of the CS-472.**

The PennDOT Concrete Field Testing Technician shall record the following data from field inspection of the concrete sampling and testing and the concrete placement conditions. Data will be recorded in the **MCCID App** or the “**Concrete Field Inspectors Daily Record Book**”. All sections shall be completed in detail for all job site concrete placements.

General placement conditions and information:

Released by; Placement Date; Time; Contractor

Concrete Supplier; Supplier Code; Anticipated CY for the day; Concrete Wasted; Type of Placement; Station Locations; Placement Method; Part of Structure Concrete placed in.

Type of Mixing and delivery

Class of Concrete; JMF / Mix ID Number; Adjusted W/C Ratio; Air Meter ID for AT/VT & QC and QA/IA

Target Slump; Slump Range; Slump Action Points; Slump Upper Limit

Air Range; Air Action Points

Concrete Temperature Range; Temperature Action Points, Air Temperature Range

Type of curing, Weather Conditions: Temperature AM, Temperature PM and conditions – (windy, rain, cloudy, etc.).

Physical test data for each load of concrete arriving on the project:

Truck number; CY on each truck; Delivery ticket serial number; Total mix water (including any added at the jobsite); Mix and Discharge times for the load

Test Type; Test results (slump, air content, temperature, W/C); No. of cylinders molded and the total revolutions on the truck mixer.

Complete Curing Log

PTM No. 1 Acceptance Test Locations

Verification Testing (VT) check boxes

Inspector's Signature and Date

The contractor's technician who molds the cylinders should sign the diary. This signature is necessary if the technician who molds the cylinders is not available for signature when the cylinders are broke.

Remarks that may affect concrete quality.

All Acceptance tests are recorded under Verification Tests in the back of the book or tracked in the MCCID App.

Air meter calibrations are recorded in back of book or in the MCCID App.

NOTE: A copy of the approved mix design and the contractor's quality control plan should be available in the field.



INDEX

	<i>Page(s)</i>
Daily Placement Record	1-102
Remarks	103-106
Wire Mesh Depth Check	107-110
Book Inspections	111-112
Yield Tests	113-114
Verification Tests	115-118
Air Meter Calibrations	119-126
P.T.M. No. 1	Inside Back Cover



Released By: **S. Inspector** Date: **10/14/17** Time: **6:00 am**

Supplier Name/Code: **ABC Ready Mix** Contractor: **XYZ Contractor**

CY/m³ for Day: **70 CY** Wasted: **1 CY** Used: **69 CY**

Type of Placement: Structural Pavement Patching Incidental Pavement RPS

Sta. **102+89** to Sta. _____ Placement Method: **Crane & Bucket**

Part of Str. Conc. Placed in: **Abutment # 1 Stem**

Plant Mixed - Delivery: Truck Agitator Truck Mixer Truck

Other Mix Methods: Truck Mixed Mobile Mixer

Class of Concrete: **A** JMF/Mix ID No.: **08-555-02** Adj W/C Ratio: **0.46**

Air Meter No. _____ AT/VT: **F-2** QA/IA: **F-3**

Target Slump: **4"** Slump Range: **2 1/2" to 5 1/2"** Slump Action Points: **±1" (3" & 5")**

Slump Upper Limit: **6 1/2"** Air Range: **4.5% to 7.5%** Air Action Points: **± 1.0%**

Conc. Temp. Range: **50° to 90°** Temp. Action Points: **± 5°** Air Temp. Range: **42° to 58°**

Type of Curing: **Wet Burlap** Weather: **Overcast**

TRUCK NO.	CY/m ³	SERIAL NO. CONCRETE PLANT SLIP	TOTAL MIXING WATER	TIME	
				Mixed	Discharged
1. 251	10	562488	324.00	6:30	7:40
2. 168	10	562489	332.00	6:45	REJECTED
3.					
4. 241	10	562491	324.00	7:15	8:20
5. 345	10	562494	324.00	8:00	9:05
6.					
7. 420	10	562495	324.00	8:20	9:30
8. 251	10	562497	324.00	8:40	9:45
9. 168	10	562499	324.00	9:00	10:10
10. 241	10	562500	324.00	9:30	10:35
11.					
12.					
13.					
14.					
15.					
16.					
17.					
18.					
19.					
20.					

Inspector's Signature: *J. B. Inspector* Date: **10/14/17**
J. Molder Cert. No. 1234

Test Types: AT - Acceptance Test QC - Quality Control Test
 VT - Verification Test RT - Retest
 QA - Quality Assurance IA - Independent Assurance

CURING LOG

DATE	TIME	CHECKED BY	AIR TEMP.	CYLINDER TEMPERATURE		CURING TEMPERATURE	
				HIGH	LOW	HIGH	LOW
10/15/17	8:30	JBI	44°	76°	68°	86°	58°
10/16/17	8:00	JBI	48°	64°	59°	64°	59°
10/17/17	9:00	JBI	38°	56°	48°	56°	48°
10/18/17	9:15	JBI	45°	58°	54°	58°	54°
10/21/17	8:00	JBI	42°	54°	52°	54°	52°
10/22/17	8:30	JBI	43°	53°	51°	53°	51°

- VT RESULTS WITHIN TOLERANCE
 VT RESULTS NOT WITHIN TOLERANCE - SEE REMARKS FOR CORRECTIVE MEASURES

TEST TYPE	TEST RESULTS			W/C RATIO	NO. CYLS. MOLDED	TOTAL REV.
	SLUMP	AIR	TEMP.			
1. QC	5 1/2"	7.0%	69°	0.46		182
2. QC	7"	7.5%	70°	0.48		258
3. RT	6 3/4"					
4. QC	6"	7.3%	70°	0.46	10	194
5. AT	5"	6.9%	71°	0.46	10	201
6. VT		7.7%	69°		2	
7. QC	4 1/2"	6.5%	71°	0.46		188
8. QC	4"	5.9%	72°	0.46		192
9.		NO TEST		0.46		205
10.		NO TEST		0.46		190
11.						
12.						
13.						
14.						
15.						
16.						
17.						
18.						
19.						
20.						

PTM NO. 1 ACCEPTANCE TEST LOCATIONS

CYL. SERIES	SEQUENCE NO.	RANDOM NO.	LOT SIZE	CY/m ³ TESTED	TEST LOAD
S-A-8	11	0.36	70 CY	25.2	3

REMARKS: Load # 2 rejected due to high slump
S-A-9 cylinders molded on load # 3 due to contractor incorporating mat'l in placement.

VERIFICATION TEST

STRUCTURAL CONCRETE			PAVEMENT CONCRETE		
DATE	AT SERIES	VT (Y/N)	DATE	AT SERIES	VT (Y/N)
1.	6/20/17	S-1-A	Y	1.	
2.	6/24/17	S-2-A	N	2.	
3.	6/29/17	S-3-A	N	3.	
4.	7/6/17	S-4-A	N	4.	
5.	7/10/17	S-5-A	N	5.	
6.	7/15/17	S-6-A	Y	6.	
7.	7/19/17	S-1-AA	N	7.	
8.	7/24/17	S-7-A	N	8.	
9.	7/28/17	S-2-AA	N	9.	
10.	8/3/17	S-1-AAA	N	10.	
11.	8/7/17	S-2-AAA	N	11.	
12.	8/14/17	S-3-AA	N	12.	
13.	8/15/17	S-4-AA	N	13.	
14.	10/14/17	S-8-A	Y	14.	
15.	10/18/17	S-9-A	N	15.	
16.	10/23/17	S-10-A	N	16.	
17.				17.	
18.				18.	
19.				19.	
20.				20.	
21.				21.	
22.				22.	
23.				23.	
24.				24.	
25.				25.	
26.				26.	
27.				27.	
28.				28.	
29.				29.	
30.				30.	

VERIFICATION TEST

PAVEMENT PATCHING CONCRETE			PAVEMENT CONCRETE RPS			
DATE	AT SERIES	VT (Y/N)	DATE	AT SERIES	VT (Y/N)	
1.			1.	7/25/17	RPS-1-AA	Y
2.			2.	7/26/17	RPS-2-AA	N
3.			3.	7/29/17	RPS-3-AA	N
4.			4.	7/30/17	RPS-4-AA	N
5.			5.	8/1/17	RPS-5-AA	N
6.			6.			
7.			7.			
8.			8.			
9.			9.			
10.			10.			
11.			11.			
12.			12.			
13.			13.			
14.			14.			
15.			15.			
16.			16.			
17.			17.			
			18.			
			19.			
INCIDENTAL CONCRETE			20.			
DATE	AT SERIES	VT (Y/N)	21.			
1.	7/2/17	M-1-A	Y	21.		
2.	7/10/17	M-2-A	N	22.		
3.				23.		
4.				24.		
5.				25.		
6.				26.		
7.				27.		
8.				28.		
9.				29.		
10.				30.		

Basic Information

App Settings

The Concrete Inspector's Diary app settings found in the main iPad Settings displays a sync behavior toggle. As a default, the auto sync is **off**. This allows valid records to automatically sync to the server when cellular/Wi-Fi connection is available.

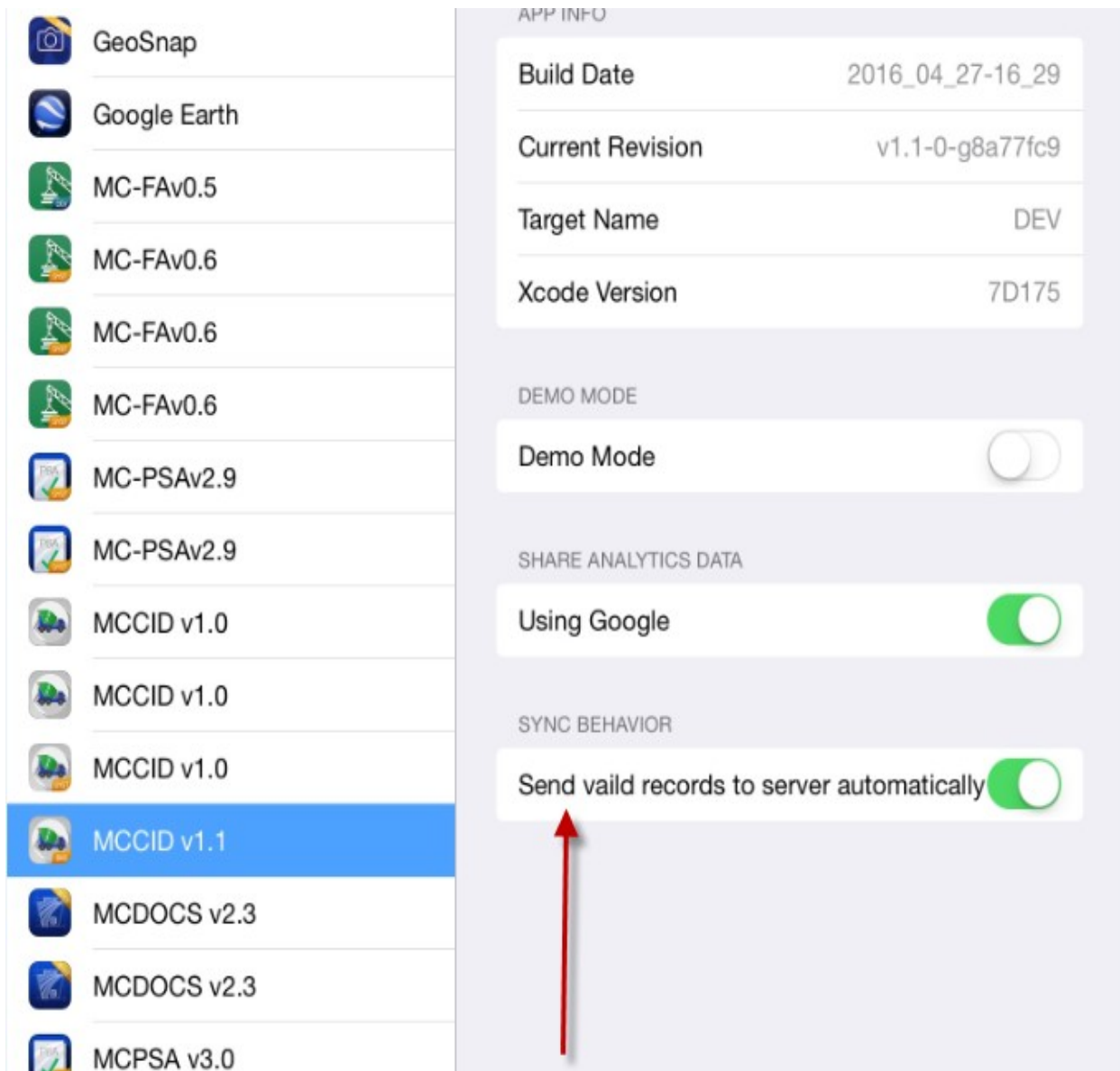

Create New/Edit Daily Placement Records

Tap on the Daily Placement Record from the Project Dashboard to present the CS-472 screen.

Add New Daily Placement Record

To add a New Daily Record, tap on the  icon. The New Daily Record screen will display. Projects with saved QC Plans will present the New Daily Record screen.

QC Plan” button will present the QC Plan screen. The “Create Blank” button will present the

Daily Record without any prepopulated QC Plan related fields.

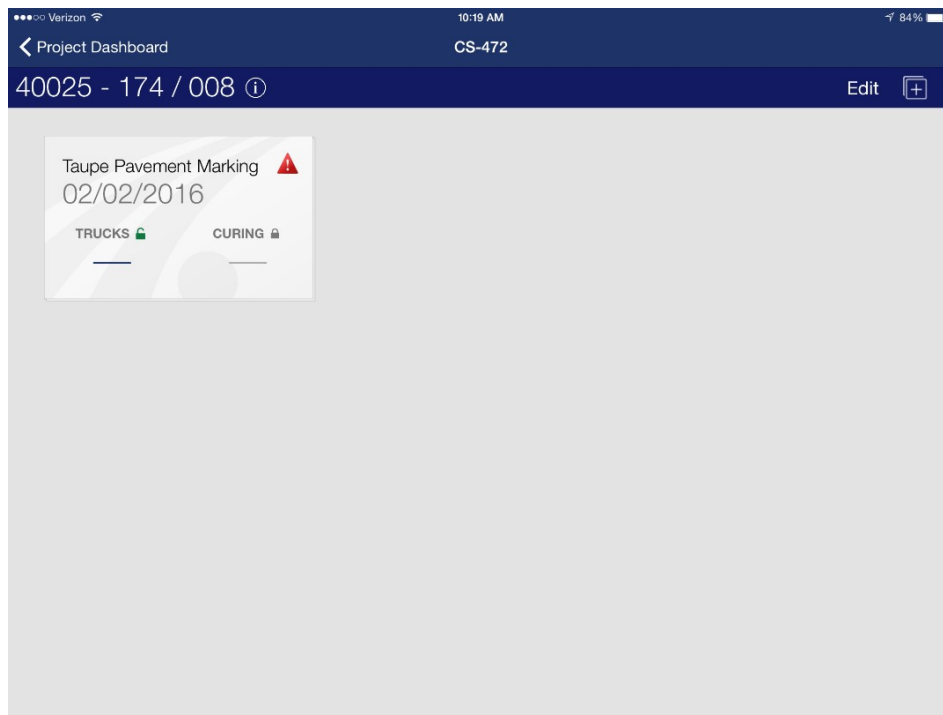
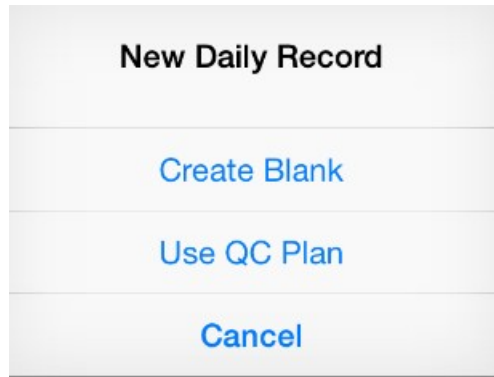

View Daily Placement Record Existing

Daily Records will display in a summary card format on the CS-472 screen. The card will display the sync icon or the validation icon. The Truck lock icon will remain open until the sync is complete for the Daily Placement Record.

Refer to PPCC for user guides and videos on how to use the MCCID App.

Go to: References-Central Office-Mobile Construction-MC CID User Guides and Videos

II.e. Reporting Compressive Strength Results CS-458A

Compressive strength test results are recorded by the Department Representative on Form CS-458A (included in the MCCID App). See completed example form provided. **The current version of the CS-458A includes areas for the Project ECMS Number and Verification Test Results.**

The header information pertains to general project information, placement location, weather, and curing conditions. Most of this information can be found in the concrete field inspector's diary.

The applied loads and corresponding compressive strengths are recorded for the appropriate day's break. Individual compressive strengths should be recorded to the nearest 10 psi.

Contractor and Department signatures are required for the persons performing the tests and the person witnessing the tests. The molder's name may be printed provided the molder has signed the concrete diary on the date the cylinders were molded.

Following POM Section B.6.10, the IIC or their delegate is to complete each Form CS-458A by entering the information required by the form in the MCCID App.

The date of loading/form removal and the date curing was discontinued should be recorded.

A statement in remarks is recommended to verify that the break results passed.

Signature of the Inspector-In-Charge is required prior to acceptance and payment.

CS-458A (6-09)

REPORT OF COMPRESSIVE STRENGTH OF PORTLAND CEMENT CONCRETE



pennsylvania
DEPARTMENT OF TRANSPORTATION

DATE COMPLETED & SENT TO DISTRICT: 07-13-2021

CLASS OF CONCRETE: AA SERIES NO.: AA-1

TEST FOR: DESIGN CONTROL IA QA

JMF NO.: 555 MIX NO.: 02

Contractor: Specialty Contractors, Inc. Producer: Ready Mixed Concrete Supply, Inc. ECMS Proj. No.: E0123456

S.R. No.: 22 Sec.: A01 County: Allegheny Station Molded: 101+46 NB RT

Concrete Placed In: 9" Type A Patches Date Molded: 06-15-2021

Weather: Sunny Air Temp.: HI 80 LOW 58 Relative Humidity: N/A

Acceptance Test: Air Content: 5.9% Concrete Temp.: 69 Slump: 4.0"

Verification Test: Air Content: 6.0% Concrete Temp.: 70 W/C Ratio: 0.45

Testing Apparatus: Make: FTE Serial No.: 02165 Date Calibrated: 01-06-2021

Quality Control Specimen Curing: First 24 HRS: Temperature: HI 78 LOW 67 After 24 HRS: Temperature: HI 80 LOW 69
Method: Cure Box Method: Plastic

Acceptance Specimen Curing: First 24 HRS: Temperature: HI 78 LOW 67 After 24 HRS: Temperature: HI 80 LOW 69
Method: Cure Box Method: Lime Bath

TEST SPEC.	Maximum Applied Load - Newtons (lbs)					Compressive Strength - kPa (PSI) Conv. Factor = Load/182.40 (28.27)				
	____ DAY QC	7-DAY QC	28-DAY QC	28-DAY AT	VERIFICATION	____ DAY QC	7-DAY QC	28-DAY QC	28-DAY AT	VERIFICATION
1		109360					3870			
2		106050					3750			
Avg.		107705					3810			
3			130820					4630		
4			133380					4720		
Avg.			132100					4675		
5				137440	134210				4860	4750
6				136530	132990				4830	4700
Avg.				136985	133600				4845	4725

Quality Control & Acceptance Tests		Verification Test	
SIGNATURE OF CONTRACTOR EMPLOYEE & DATE	SIGNATURE OF DOT REPRESENTATIVE & DATE	SIGNATURE OF DOT REPRESENTATIVE & DATE	SIGNATURE OF CONTRACTOR EMPLOYEE & DATE
MOLDED BY: J. Molder 06-15-2021	WITNESSED BY: B. Witnesser 06-15-2021	MOLDED BY: B. Witnesser 06-15-2021	WITNESSED BY: J. Molder 06-15-2021
CERT NO.: 1234	METHOD OF CAPPING: <input type="checkbox"/> NEOPRENE <input type="checkbox"/> SULFUR	CERT NO.: 4321	METHOD OF CAPPING: <input type="checkbox"/> NEOPRENE <input type="checkbox"/> SULFUR
7-DAY TESTED BY: T. Tester 06-22-2021	WITNESSED BY: S. Looker 06-22-2021	TESTED BY: T. Tester 07-13-2021	WITNESSED BY: S. Looker 07-13-2021
28-DAY TESTED BY: T. Tester 07-13-2021	WITNESSED BY: S. Looker 07-13-2021	REPORTED BY: S. Looker 07-13-2021	
____ DAY TESTED BY:	WITNESSED BY:	REMARKS:	
DATE OF LOADING/FORM REMOVAL: 06-22-2021	All breaks pass for 100% Pay		
DATE FIELD CURING DISCONTINUED: 06-22-2021	VT within Tolerance		

Inspector In Charge: *B. Boss*

COMPRESSIVE REPORT INFO
General

Date Completed & Sent to District: 11/23/2021	Test For: Control	Class of Concrete: AA
Series No: S-AT-AA-7	JMF No: M	Mix #: 430
Contractor: XYZ Contractor	Producer: ABC Ready Mix	ECMS Project No: 12345
S.R. No: 80	Section: B41	County: Clearfield

Molding

Station Molded: S-38631 EB	Date Molded: 10/26/2021	Concrete Placed In: Cheek Walls
Weather: Cloudy	Relative Humidity: null%	Air Temperature: 90°-50°

Testing
Testing Apparatus

Make: Forney	Serial No: 6810502005	Date Calibrated: 01/22/2021
---------------------	------------------------------	------------------------------------

Acceptance Test

Air Content: 6.00%	Concrete Temperature: 64°	Slump: 4.00 in
---------------------------	----------------------------------	-----------------------

Verification Test

Air Content: -	Concrete Temperature: --	Slump: --
-----------------------	---------------------------------	------------------

Quality Control
First 24 Hrs

Temperature: 84° - 86°	Method: Cure Box
-------------------------------	-------------------------

After 24 Hrs

Temperature: 50° - 74°	Method: Field
-------------------------------	----------------------

Acceptance
First 24 Hrs

Temperature: 84° - 86°	Method: Cure Box
-------------------------------	-------------------------

After 24 Hrs

Temperature: 70° - 76°	Method: Lime Bath
-------------------------------	--------------------------

MAX APPLIED LOAD / COMPRESSIVE STRENGTH

Sample Age	Test Type	Max Applied Load	Compressive Strength	Test Performed On	Test Performed By	Pass / Fail
7-Day	QC	114670	4060	11/02/2021	J. Tester/PennDOT BP-000000	Pass
7-Day	QC	116720	4130	11/02/2021	J. Tester/PennDOT BP-000000	Pass
28-Day	AT	141500	5000	11/23/2021	M. Tester/PennDOT	Pass
28-Day	QC	131000	4630	11/23/2021	M. Tester/PennDOT	Pass
28-Day	AT	139500	4930	11/23/2021	M. Tester/PennDOT	Pass
28-Day	QC	135000	4770	11/23/2021	M. Tester/PennDOT	Pass

QUALITY CONTROL

Molded By	B. Molder	10/26/2021 07:55 AM
-----------	-----------	---------------------

Witnessed By	J. Witnesser/PennDOT BP-000000	10/26/2021 07:55 AM
--------------	--------------------------------	---------------------

Cert No	1234	Method Of Capping	--
----------------	-------------	--------------------------	-----------

II.f. Water / Cement Ratio Determination

For purposes here, water/cement ratio shall be referred to as *water/cementitious* ratio, where C is equal to the total cementitious material (Portland cement, fly ash, silica fume, or slag cement) in the mix.

The Water/Cementitious ratio is
$$\frac{\text{Total Water (by weight)}}{\text{Total Cementitious (by weight)}}$$

To determine the W/C ratio:

- Calculate the total water (by weight)
- Calculate the total cementitious material (by weight)
- Divide the total weight of water by the total weight of cementitious material

Total Water = Batched Water + Surface Moisture in Aggregates + Wash Down Water (if any) + Ice (if any)

Total Cementitious = Cement + Pozzolan

The **W/C ratio** for any given load of concrete can be determined from information on the Batcher – Mixer Slip and the Delivery ticket.

408/704 Maximum W/C

Class of Concrete	Max W/C
AAAP	0.45
AAAP LW	0.45
AAA	0.43
AA	0.47
AA LW	0.47
ASC	0.47
A	0.50
C	0.66
HES	0.40

Determining W/C from the Batchers – Mixer Slip / Delivery Ticket

Read Quantity of Concrete for the Load (in CY) from the Delivery ticket.

Read Batched Mixing Water (in lbs.) from the Delivery ticket.

Read Surface Moisture in Aggregates (in lbs. per c.y.) from Batchers-Mixer Slip

Read Wash Down Water from Delivery Tickets (in lbs) (if in gals. multiply by 8.33 lbs/gal.)

Total Water = Batched Water + Surface Moisture + Wash Down Water

Read Total Cementitious Material from the delivery ticket (in lbs.)

Check against Cement & Pozzolan weights on Batchers-Mixer Slip

W/C ratio = Total Water / Total Cementitious

From the information provided on the following pages:

Total Quantity of Concrete delivered for the Load = 10 CY

Total Batched Water = 1947 lbs.

Total Surface Moisture = 62 lbs./CY X 10 CY = 620 lbs.

Total Wash Down Water = 10 gals. X 8.33 lbs./gal. = 83 lbs.

Total Water = 1947 + 620 + 83 = 2650 lbs.

Total Cementitious Material = 5000 lbs Cement + 880 lbs Fly Ash = 5880 lbs.

W/C = 2650/5880 = 0.45

Review the approved mix design to verify the plant is sending Adjusted Mix #2 with the proper amount of water.

If water is requested to be added to adjust the slump, determine the amount which may be added based on the mix design. Subtract 31.8 gals./CY from 33.2 gals./CY = 1.4 gals./CY.

The maximum permitted by POM B/6/17 is less than 1.4 gals./CY, therefore, only 1 gal./CY may be added if permitted by the DME/DMM!



Ready Mixed Concrete Supply, Inc.
 P.O. Box 119 S. Pittsburgh, PA 15222
 Supplier Code RMC02A42

50555

MATERIALS TICKET

CUSTOMER NO.	P.O. NUMBER	PROJECT NUMBER	TRUCK NUMBER	TIME	DATE	TICKET NO.
111101		ECMS 67777	121	8:00 AM	6/15/2021	1-50555

SOLD TO	DELIVERED TO
SPECIALTY CONTRACTORS, INC.	SR 0022 SEC A01

PRODUCT CODE	PRODUCT DESCRIPTION	QUANTITY	UNIT OF MEAS	UNIT PRICE	AMOUNT
JMF - 555 - 2	PennDOT CLASS AA CONCRETE	10.00	CY		

LEAVE YARD	ON JOB	BEGIN POUR	USE OF CONCRETE		SUB-TOTAL
FINISH POUR	OFF JOB		TARGET SLUMP	WATER ADDED GALLONS	TAX
			3 1/2"		TOTAL MTL

I CERTIFY THAT THIS LOAD MEETS PennDOT 408 SPECIFICATIONS				METHOD OF CONCRETE MIXING	
X <u>J. TECHNIGIAN</u>				<input checked="" type="checkbox"/> TRUCK MIXED <input type="checkbox"/> CENTRAL MIXED	
No. 57	17730	LBS.			
SAND	12270	LBS.			
PORTLAND CEMENT	5000	LBS.			
FLY ASH	880	LBS.			
TOTAL BATCHWATER	1947	LBS.			
			WASH DOWN WATER = <i>10 gals</i>		
ADMIXTURE	AIR ENTRAINMENT	59	OZ.		
ADMIXTURE	WATER REDUCER	176	OZ.		
ADMIXTURE	RETARDER	118	OZ.		
ADMIXTURE			OZ.		
MIXING REVOLUTIONS		100	REVS		

Our drivers are instructed not to make deliveries beyond the curb line or existing road width unless directed by purchaser. We assume no liability for damage to property or for any instructions given to operators by purchaser, agent, owner, or contractor.

Cement Burn Warning: Caution: Avoid skin contact. May cause eye or skin injury. Contains Portland cement. Freshly mixed cement, mortar, or grout may cause skin injury. Take these precautions: Avoid all contact with eyes. Wear rubber boots and gloves and avoid prolonged contact directly with skin or through porous materials. In case of contact with skin or eyes, FLUSH THOROUGHLY WITH WATER. If irritation persists, get medical attention promptly. Keep children away. Read MSDS on reverse side.

I acknowledge the receipt of the material safety sheet information on the reverse side.
 CUST. SIGN. _____



Ready Mixed Concrete Supply, Inc.
P.O. Box 119 S. Pittsburgh, PA 15222
Supplier Code RMC02A42

50555

MATERIALS TICKET

CUSTOMER NO.	P.O. NUMBER	PROJECT NUMBER	TRUCK NUMBER	TIME	DATE	TICKET NO.
111101		ECMS 67777	121	8:00 AM	6/15/2021	1-50555

SOLD TO	DELIVERED TO
SPECIALTY CONTRACTORS, INC.	SR 0022 SEC A01

PRODUCT CODE	PRODUCT DESCRIPTION	QUANTITY	UNIT OF MEAS	UNIT PRICE	AMOUNT
JMF - 555 - 2	PennDOT CLASS AA CONCRETE	10.00	CY		

LEAVE YARD	ON JOB	BEGIN POUR	USE OF CONCRETE		SUB-TOTAL
			TARGET SLUMP	WATER ADDED GALLONS	TAX
			3 1/2"		TOTAL MTL

I CERTIFY THAT THIS LOAD MEETS PennDOT 408 SPECIFICATIONS X <u>J. TECHNIGIAN</u>	METHOD OF CONCRETE MIXING
	<input checked="" type="checkbox"/> TRUCK MIXED <input type="checkbox"/> CENTRAL MIXED

No. 57	17730	LBS.	
SAND	12270	LBS.	
PORTLAND CEMENT	5000	LBS.	
FLY ASH	880	LBS.	
TOTAL BATCH WATER	1947	LBS.	WASH DOWN WATER = 10 gals
ADMIXTURE	AIR ENTRAINMENT	59	OZ.
ADMIXTURE	WATER REDUCER	176	OZ.
ADMIXTURE	RETARDER	118	OZ.
ADMIXTURE			OZ.
MIXING REVOLUTIONS		100	REVS

Our drivers are instructed not to make deliveries beyond the curb line or existing road width unless directed by purchaser. We assume no liability for damage to property or for any instructions given to operators by purchaser, agent, owner, or contractor.

Cement Burn Warning: Caution: Avoid skin contact. May cause eye or skin injury. Contains Portland cement. Freshly mixed cement, mortar, or grout may cause skin injury. Take these precautions: Avoid all contact with eyes. Wear rubber boots and gloves and avoid prolonged contact directly with skin or through porous materials. In case of contact with skin or eyes, FLUSH THOROUGHLY WITH WATER. If irritation persists, get medical attention promptly. Keep children away. Read MSDS on reverse side.

I acknowledge the receipt of the material safety sheet information on the reverse side.
CUST. SIGN. _____

CS-4220 (10-21)



pennsylvania
DEPARTMENT OF TRANSPORTATION

Batcher Mixer Slip

Date 6/15/2021

Time 7:30

JMF Number 555-02

ECMS 67777

Contractor		Specialty Contractors, Inc.		Plant		Ready Mixed Concrete Supply, Inc.	
County		Allegheny		Project Location		S. Pittsburg (RMC02A42)	
S.R.	22	SECTION	A01	Design Gallons of Water Per Cubic Yard		31.80	
Class Concrete	AA	W/C Ratio	0.45	Design Gallons of Water - Admixture Water Per C.Y		31.80	
MATERIALS		SATURATED SURFACE DRY WEIGHT (lbs)	SURFACE MOISTURE (%)	SURFACE MOISTURE (lbs)	BATCH WEIGHT PER C.Y. (lbs)		
Cement		500			500		
SCM	Fly Ash	88			88		
SCM							
Sand		1168	4.10%	48	1216		
#57		1776	0.80%	14	1790		
Admixture [oz.]		Weight per gal				Admixture (Solids+Water) [lbs]	
Admixture [oz.]		Weight per gal				Admixture (Solids+Water) [lbs]	
	Ice [lbs]					Ice-Water [lbs]	
Target Slump	4.00	Surface Moisture in Aggregates [lbs]		62.00			
% Air	6.0	Surface Moisture in Aggregates [gals]		7.44			
		Batched Mixing Water [gals]		24.36	203	Batched Mixing Water [lbs]	
PENNDOT Field Inspector (who gave release)		J.B. Inspector		Total Batch Weight		3797	lbs.
PENNDOT Plant Inspector		D.M. Inspector		Batch Yield		27	cu. ft.
Concrete Plant Technician		J. Technician		Wt/Cu.Ft.		140.63	lbs./cu.ft.

<p>TR-4221 (12-15)</p>  <p>pennsylvania DEPARTMENT OF TRANSPORTATION</p>	Concrete Mix Design Form		Producer	Ready Mix Concrete Supply Inc.
			Location	
			Contractor	
			Sec/Segment	
			SR/VO	
			Material Class	AA
			Mix Identifier	
			Structure Class	
			ECMS No./PO No.	
			JMF Status	Approved

Material	Material Code	Material Class	Product Name	Producer Name	Supplier Code	Sp. Gr.	Abs	ASR	
Cement	276	1		PA Cement Company - Boomerville	PAC0 15	3.150	0.00		
Pozzolan	276	F		Ash Supply Company - Danville, PA	ASC0 15	2.400	0.00		
Coarse Aggregate	203	A57		Big Rocks Stone Company - Bedrock	BRS02A 14	2.600	0.46	0.02	
Fine Aggregate	207	A		Gravel Sand Company - Sand Lake	GSC02A14	2.588	1.16		
Water	420	WTRMIX	City of Pittsburgh	No Bulletin 15 Listing	NOBLT 15	1.000			
						Oz/cwt	Oz/yd	Mfg Dose/cwt	
								Min	Max
Admixture	403	AEA	AE120	Admixtures, Inc.	ADM0 15	1.00	5.88		
Admixture	403	WR	WR150	Admixtures, Inc.	ADM0 15	3.00	17.64	2.00	6.00
Admixture	403	RE	RE750	Admixtures, Inc.	ADM0 15	2.00	11.76	2.00	5.00

When RE admixture is used in concrete $\geq 80^{\circ} F$ or in hot weather, the manufacturer's minimum recommended dosage rate for RE admixture must be used to get 90 minutes of mixing time.

When using HRWR admixture, it must be used at the manufacturer's minimum dosage rate to use the maximum of 8" slump per 704.1(d)a.

When using a WR admixture, it must be used at manufacturer's minimum dosage rate to use the maximum of 61/2" slump spec per 704.1(d)4.a.

Any additional admixtures utilized to enhance the concrete performance may be below the manufacturer's minimum recommended usage rate.

RCP Coulombs 1547 Total admix water per cubic yard From trial mix dated 11/22/2005

Microstrain Total admix solids per cubic yard 28/7 ratio from worksheet dated 11/22/2005

Strength Data Based on Max W/C 0.470 28/7 day strength ratio (AAP Only) % Air 6.00

F^oc (Compressive Strength) PSI

7 Days	4,830 Avg PSI	14 Days	5,675 Avg PSI	28 Days	6,275 Avg PSI	56 Days	8,390 Avg PSI
--------	---------------	---------	---------------	---------	---------------	---------	---------------

	Material Code	Material Class	Supplier Code	Max W/C	Mix # 2	Mix # 3	Mix # 4	Mix # 5	
W/C Ratio by wt.				0.470	0.450	0.430	0.410	0.390	
Cement (lbs)	276	1	PAC0 15	500	500	500	500	500	
Pozzolan (lbs)	276	F	ASC0 15	88	88	88	88	88	
Total Cementitious (lbs)				588	588	588	588	588	
Coarse Agg. (lbs)	203	A57	BRS02A 14	1776	1776	1776	1776	1776	
Total Coarse Agg. (lbs)				1776	1776	1776	1776	1776	
Fine Agg. (lbs)	207	A	GSC02A14	1137	1168	1199	1230	1261	
Total Water (lbs)				276	265	253	241	229	
Admixture Water (lbs)									
Mix Water (lbs)				276	265	253	241	229	
Admixture Solids/yd (lbs)									
Total (lbs)				3777	3796	3816	3835	3855	
Unit Weight (lbs/cu.ft.)				139.88	140.60	141.32	142.04	142.76	
Coarse Agg. (cu.ft)				10.95	10.95	10.95	10.95	10.95	
Total Water (gal.)				33.2	31.8	30.4	28.9	27.5	
Mix Water (gal.)				33.2	31.8	30.4	28.9	27.5	

Designed By : W.. Girad Designed Date : 5/5/21

Submitted By : J. Johnson Submitted Date : 5/6/21

District Approver : T Jones, DME 11-0 Approved Date : 5/12/21

II.g. Water / Cement Ratio Determination by Batch Plant Printout

In the previous examples for determining W/C ratio, you were able to identify the total amount of surface moisture in the aggregates from the batcher mixer slip and the batched water and batched cement from the delivery ticket.

Some concrete plants are automated with moisture probes that determine the actual percentage of moisture for each load. The plant will then automatically batch the proper amount of water for the mix based on the surface moisture in the aggregates obtained from the moisture probes. (The probes are primarily used with the fine aggregates as they are most susceptible to ongoing moisture variations. The coarse aggregate moisture generally stays fairly constant). (Although equipped with moisture probes some plants do not use them. So, it is advisable to contact supplier prior to placement for determination.)

These batch weights are shown on the delivery ticket for each load. We have included a generic ticket for an automated batch plant showing all the required information. This printout format will vary from plant to plant, but all the required information will be on the ticket in some form or another. It is important to be familiar with the format of your delivery tickets prior to the start of any placement.

The concrete plant technician is still required to run moisture tests on the aggregates prior to shipping and every 4 hours thereafter and must still send a completed Batcher Mixer slip to the project. While not needed to compute the W/C ratio, it still gives you a check that you are getting the correct mix and in the correct proportion.

Check the batch weights and moisture from the 1st delivery ticket against the results shown on the Batcher Mixer slip. Your delivery tickets results should have values close to the Batcher Mixer slip but won't be exact as each batch is automatically compensating for moisture in the aggregates and will provide slightly different results based on the readings from the probes.

Note: The W C ratio listed on the delivery ticket may not match the actual calculated W/C ratio. The W/C ratio should always be calculated using the following procedure.



Ready Mixed Concrete Supply, Inc.

50555

P.O. Box 119 S. Pittsburg, PA 15222
Supplier Code RMC02A42

MATERIALS TICKET

CUSTOMER NO.	P.O. NUMBER	PROJECT NUMBER	TRUCK NUMBER	TIME	DATE	TICKET NO.
111101		ECMS67777	121	8:00 AM	6/15/2021	1-50555

SOLD TO SPECIALTY CONTRACTORS, INC.		DELIVERED TO SR0022 SECA01	
--	--	-------------------------------	--

PRODUCT CODE	PRODUCT DESCRIPTION	QUANTITY	UOM	Unit Price	Amount
JMF - 555 - 2	PennDOTCLASSAACONCRETE	10.00	CY		

LEAVEYARD	ONJOB	BEGINPOUR	USE OF CONCRETE		SUB-TOTAL
FINISH POUR	OFFJOB	TARGET SLUMP	WATER ADDED GALLONS		TAX
		3 1/2"			TOTAL MTL

I CERTIFY THAT THIS LOAD MEETS PennDOT 408 SPECIFICATIONS X <u>J. Technician</u>	METHOD OF CONCRETE MIXING	
	<input checked="" type="checkbox"/> TRUCK MIXED	<input type="checkbox"/> CENTRAL MIXED

	ACTUAL		TARGET		%TOLERANCE	%MOISTURE
NO. 57	17730	LBS.	17900	LBS.	- 0.4	0.8
SAND	12270	LBS.	12290	LBS.	- 0.2	5.2
CEMENT	5020	LBS.	5000	LBS.	+0.4	
FLY ASH	885	LBS.	880	LBS.	+0.6	
TOTAL BATCH WATER	1900	LBS.	1900	LBS.	+0.0	
ADMIXTURE	AIR ENTRAINMENT	59	59	oz.	+0.0	
ADMIXTURE	WATER REDUCER	178	176	oz.	+1.1	
ADMIXTURE	RETARDER	118	118	oz.	+0.0	
ADMIXTURE				oz.		Calculated W/C Ratio
MIXING REVOLUTIONS	100	REVS				0.44

Our drivers are instructed not to make deliveries beyond the curb line or existing road width unless directed by purchaser. We assume no liability for damage to property or for any instructions given to operators by purchaser, agent, owner or contractor.
 Cement Burn Warning: Caution: Avoid skin contact. May cause eye or skin injury. Contains Portland cement. Freshly mixed cement, mortar, or grout may cause skin injury. Take these precautions: Avoid all contact with eyes. Wear rubber boots and gloves and avoid prolonged contact directly with skin or through porous materials. In case of contact with skin or eyes, FLUSH THOROUGHLY WITH WATER. If irritation persists, get medical attention promptly. Keep children away. Read MSDS on reverse side.

I acknowledge the receipt of the material safety sheet information on the reverse side.
 CUST. _____
 SIGN. X _____

Based on the information from the delivery ticket, there is a 5-step process to determine the W/C ratio.

1. **Determine surface moisture in the fine aggregate**
2. **Determine surface moisture in the coarse aggregate**
3. **Determine total water**
4. **Determine total cementitious material**
5. **Calculate the W/C ratio**

The worksheet on the next page shows you the process step by step

Step 1 is to determine the **moisture in the fine aggregate** by determining the ssd weight of the fine aggregate, given the % moisture in the sand, and subtracting the weight from the fine aggregate scale weight.

Note: The 12270 lb scale value is the weight of the sand **and** the water in the sand. Taking 5.2% of the value gives you a false volume of water that is higher than the actual water in the sand and will give you a higher W/C ratio. That is why you need to perform this calculation to obtain the proper amount of water in the sand. Remember you are only looking for the surface moisture of the aggregate.

Step 2 is to determine the **moisture in the coarse aggregate** using the same procedure.

Step 3 is to determine the **Total Water** by adding the batched mixing water to the moisture in the fine and coarse aggregate. In this example, there was no wash down water nor ice indicated on the Delivery Ticket. If either would have been indicated, it would need to be added into the Total Water.

Step 4 is to determine the **Total Cementitious** material by adding the cement scale weight and the pozzolan scale weight.

Step 5 is to calculate the **W/C ratio** by dividing the **Total Water** by the **Total Cementitious** material.

Finally, as a check, look at the Mix Design #21-555 on Page 51 and confirm that your water/cement ratio is correct for Adjusted Mix #2, which has a $W/C = 0.45$.

A blank copy of the worksheet has also been included that you may copy and use in the field when you are receiving concrete from a batch plant with a recorded ticket.

Sample Worksheet for Determining W/C Ratio from Batch Plant Printout

Record Necessary Information:	Batched Mixing Water	<u>1900</u> lbs.
	Fine Aggregate Scale Weight	<u>12270</u> lbs.
	Fine Aggregate Moisture	<u>5.2</u> % ÷ 100 = <u>0.052</u>
	Coarse Aggregate Scale Weight	<u>17730</u> lbs.
	Coarse Aggregate Moisture	<u>0.8</u> % ÷ 100 = <u>0.008</u>
	Portland Cement Scale Weight	<u>5020</u> lbs.
	Pozzolan Scale Weight	<u>885</u> lbs.

Determine surface moisture in the fine aggregate by subtracting SSD weight from the Scale weight.

Calculate SSD weight of the fine aggregate by dividing the fine aggregate Scale weight by the surface moisture, expressed as a decimal, plus 1.

$$\text{SSD weight of the fine aggregate} = \frac{\text{Scale weight of fine aggregate}}{\text{surface moisture as decimal} + 1} = \frac{12270}{1.052} = 11663 \text{ lbs.}$$

fine aggregate Scale weight – fine aggregate SSD weight = fine aggregate surface moisture

$$\underline{12270} - \underline{11663} = \underline{607} \text{ lbs.}$$

Determine surface moisture in the coarse aggregate by subtracting SSD weight from the Scale weight.

Calculate SSD weight of the coarse aggregate by dividing the coarse aggregate Scale weight by the surface moisture, expressed as a decimal, plus 1.

$$\text{SSD weight of the coarse aggregate} = \frac{\text{Scale weight of coarse aggregate}}{\text{surface moisture as decimal} + 1} = \frac{17730}{1.008} = 17589 \text{ lbs.}$$

coarse aggregate Scale weight – coarse aggregate SSD weight = coarse aggregate surface moisture

$$\underline{17730} - \underline{17589} = \underline{141} \text{ lbs.}$$

Determine the Total Water in the mix.

Batched Water + fine aggregate Surface Moisture + coarse aggregate Surface Moisture = Total Water

$$\underline{1900} + \underline{607} + \underline{141} = \underline{2648} \text{ lbs.}$$

Determine the Total Cementitious in the mix.

Portland Cement Scale weight + pozzolan Scale weight = Total Cementitious

$$\underline{5020} + \underline{885} = \underline{5905} \text{ lbs.}$$

Calculate the W/C Ratio.

Total Water ÷ Total Cementitious = W/C Ratio

$$\underline{2648} \div \underline{5905} = \underline{0.45}$$

Sample Worksheet for Determining W/C Ratio from Batch Plant Printout

Record Necessary Information:

Batched Mixing Water		_____ lbs.
Fine Aggregate Scale Weight		_____ lbs.
Fine Aggregate Moisture	_____ % ÷ 100	_____
Coarse Aggregate Scale Weight		_____ lbs.
Coarse Aggregate Moisture	_____ % ÷ 100	_____
Portland Cement Scale Weight		_____ lbs.
Pozzolan Scale Weight		_____ lbs.

Determine surface moisture in the fine aggregate by subtracting SSD weight from the Scale weight.
 Calculate SSD weight of the fine aggregate by dividing the fine aggregate Scale weight by the surface moisture, expressed as a decimal, plus 1.

$$\text{SSD weight of the fine aggregate} = \frac{\text{Scale weight of fine aggregate}}{\text{surface moisture as decimal} + 1} = \frac{\quad}{\quad} = \quad \text{lbs.}$$

fine aggregate Scale weight – fine aggregate SSD weight = fine aggregate surface moisture

$$\quad - \quad = \quad \text{lbs.}$$

Determine surface moisture in the coarse aggregate by subtracting SSD weight from the Scale weight.
 Calculate SSD weight of the coarse aggregate by dividing the coarse aggregate Scale weight by the surface moisture, expressed as a decimal, plus 1.

$$\text{SSD weight of the coarse aggregate} = \frac{\text{Scale weight of coarse aggregate}}{\text{surface moisture as decimal} + 1} = \frac{\quad}{\quad} = \quad \text{lbs.}$$

coarse aggregate Scale weight – coarse aggregate SSD weight = coarse aggregate surface moisture

$$\quad - \quad = \quad \text{lbs.}$$

Determine the Total Water in the mix.

Batched Water + fine aggregate Surface Moisture + coarse aggregate Surface Moisture = Total Water

$$\quad + \quad + \quad = \quad \text{lbs.}$$

Determine the Total Cementitious in the mix.

Portland Cement Scale weight + pozzolan Scale weight = Total Cementitious

$$\quad + \quad = \quad \text{lbs.}$$

Calculate the W/C Ratio.

Total Water ÷ Total Cementitious = W/C Ratio

$$\quad \div \quad = \quad$$

<p>TR-4221 (12-15)</p> 	Concrete Mix Design Form		Producer	Ready Mix Concrete Supply Inc.
			Location	
			Contractor	
			Sec/Segment	
			SR/WO	
			Material Class	AA
			Mix Identifier	
			Structure Class	
			ECMS No./PO No.	
			JMF Status	Approved

Material	Material Code	Material Class	Product Name	Producer Name	Supplier Code	Sp. Gr.	Abs	ASR	
Cement	276	1		PA Cement Company - Boomerville	PAC0 15	3.150	0.00		
Pozzolan	276	F		Ash Supply Company - Danville , PA	ASC0 15	2.400	0.00		
Coarse Aggregate	203	A57		Big Rocks Stone Company - Bedrock	BRS02A 14	2.600	0.46	0.02	
Fine Aggregate	207	A		Gravel Sand Company - Sand Lake	GSC02A14	2.588	1.16		
Water	420	WTRMIX	City of Pittsburgh	No Bulletin 15 Listing	NOBLT 15	1.000			
						Oz/cwt	Oz/yd	Mfg Dose/cwt	
								Min	Max
Admixture	403	AEA	AE120	Admixtures, Inc.	ADM0 15	1.00	5.88		
Admixture	403	WR	WR150	Admixtures, Inc.	ADM0 15	3.00	17.64	2.00	6.00
Admixture	403	RE	RE750	Admixtures, Inc.	ADM0 15	2.00	11.76	2.00	5.00

When RE admixture is used in concrete $\geq 80^{\circ} F$ or in hot weather, the manufacturer's minimum recommended dosage rate for RE admixture must be used to get 90 minutes of mixing time.

When using HRWR admixture, it must be used at the manufacturer's minimum dosage rate to use the maximum of 8" slump per 704.1(d)a.

When using a WR admixture, it must be used at manufacturer's minimum dosage rate to use the maximum of 61/2" slump spec per 704.1(d)4.a.

Any additional admixtures utilized to enhance the concrete performance may be below the manufacturer's minimum recommended usage rate.

RCP Coulombs 1547 Total admix water per cubic yard From trial mix dated 11/22/2005

Microstrain Total admix solids per cubic yard 28/7 ratio from worksheet dated 11/22/2005

Strength Data Based on Max W/C 0.470 28/7 day strength ratio (AAP Only) % Air 6.00

F°C (Compressive Strength) PSI

7 Days	4,830 Avg PSI	14 Days	5,675 Avg PSI	28 Days	6,275 Avg PSI	56 Days	8,390 Avg PSI
--------	---------------	---------	---------------	---------	---------------	---------	---------------

	Material Code	Material Class	Supplier Code	Max W/C	Mix # 2	Mix # 3	Mix # 4	Mix # 5	
W/C Ratio by wt.				0.470	0.450	0.430	0.410	0.390	
Cement (lbs)	276	1	PAC0 15	500	500	500	500	500	
Pozzolan (lbs)	276	F	ASC0 15	88	88	88	88	88	
Total Cementitious (lbs)				588	588	588	588	588	
Coarse Agg. (lbs)	203	A57	BRS02A 14	1776	1776	1776	1776	1776	
Total Coarse Agg. (lbs)				1776	1776	1776	1776	1776	
Fine Agg. (lbs)	207	A	GSC02A14	1137	1168	1199	1230	1261	
Total Water (lbs)				276	265	253	241	229	
Admixture Water (lbs)									
Mix Water (lbs)				276	265	253	241	229	
Admixture Solids/yd (lbs)									
Total (lbs)				3777	3796	3816	3835	3855	
Unit Weight (lbs/cu.ft.)				139.88	140.60	141.32	142.04	142.76	
Coarse Agg. (cu.ft)				10.95	10.95	10.95	10.95	10.95	
Total Water (gal.)				33.2	31.8	30.4	28.9	27.5	
Mix Water (gal.)				33.2	31.8	30.4	28.9	27.5	

Designed By : W.. Girad Designed Date : 5/5/21

Submitted By : J. Johnson Submitted Date : 5/6/21

District Approver : T Jones, DME 11-0 Approved Date : 5/12/21

Commentary:

The maximum W/C ratio for each design is listed on the mix design form. It is the W/C ratio that the strength results are determined by, not the values listed on any adjusted or step-down mix. This is the amount of water that must not be exceeded whenever water is added to a mix for workability.

Certain accelerating or corrosion inhibiting admixtures may be required in large enough doses that the water from these admixtures needs to be added into the total water when determining the W/C ratio. As a general rule of thumb, when the water in the admixture reaches 1 gal/cy the admixture liquid should be accounted for in the calculation of W/C ratio.

Some newer batch computers print out the water/cementitious ratio for each batch. This should be checked to ensure the proper info has been input into the computer.

It is essential that the Contractor's technician and the Department Representative familiarize themselves with, and understand, the ready-mix producer's printout prior to delivery of concrete to the project.

Special Note:

1 gallon of water = 8.33 lbs.

1 pound of ice = 1 pound of water.

Review Questions

II. Project Documentation

1. Concrete delivery tickets must contain the signature of the plant technician or designated company representative. True / False
2. The Water/Cement ratio is the Total Water (by weight) divided by the Total Cementitious material (by weight). True / False
3. At the start of a concrete operation and prior to the field adjustment of any mixes, the technician and inspector must have the following information at the placement:
_____, _____, _____, and _____.
4. A concrete mix design must be reviewed by the DME/DMM prior to use? True / False
5. A batcher-mixer slip is to be provided with the first truck and at a minimum of every 4 hours during the placement. True / False
6. Compressive strength test results are reported on Form _____.
7. Total cementitious material used to determine the Water/Cement ratio of a mix includes, by weight, Portland cement, _____, _____, or _____.
8. It is acceptable for a contractor's technician to sign the Concrete Field Inspector's Diary if the technician who molds the cylinders is not available for signature when the cylinders are tested for compressive strength. True / False
9. One gallon of water weighs _____ pounds.
10. Calculate the Water/Cement ratio given the total cementitious material is 5,880 lbs. and the total water is 304 gallons. _____.
11. One pound of ice is equal to _____ pound of water.
12. The maximum Water/Cement ratio for a Class AAAP mix design is _____.
13. When completing Form CS-458A, individual compressive strengths are recorded to the nearest _____ psi.
14. Calculate the W/C ratio given the following information for a 10 CY load: From the delivery ticket the total cementitious material 6580 lbs and the total batched water is 2048 lbs. From the batcher mixer slip, there is 65 lbs. of surface moisture per CY.
_____.

Review Questions – cont'd

II. Project Documentation

15. When computing W/C ratio in mixes using certain accelerating or corrosion inhibiting admixtures, the admixture liquid needs to be included with the total water when the dosage is _____ gal/CY.
16. Total water in the concrete mix includes batched water plus _____ plus _____.
17. Only the front sheet of the Master Concrete Mix Design (TR-4221A) needs to be submitted to the project. True / False
18. A concrete mix has a maximum W/C ratio of 0.47 based on total water in the mix of 33.2 gal/CY. A 10 CY load of concrete from a step-down interval of this mix is delivered to the project. The batched water is 2118 pounds for the load. The batcher-mixer slip tells you the surface moisture in the aggregates is 7.1 gal/CY. The W/C ratio for this step-down interval is 0.46. If the contractor is permitted to add water to improve the workability, how many gal/CY can be added to the load? _____
19. A Batch Plant Printout indicates a coarse aggregate scale weight of 17,848 lbs and a coarse aggregate surface moisture of 0.8%. The amount of surface moisture in the coarse aggregate would be _____ lbs.
20. Determine the W/C Ratio using the Batch Plant Printout Method using the following Printout Information. The W/C Ratio for the load is _____.

Batched Mixing Water	1880 lbs
Fine Aggregate Scale Weight	12200 lbs
Fine Aggregate Moisture	4.8%
Coarse Aggregate Scale Weight	17709 lbs
Coarse Aggregate Moisture	0.9%
Total Cementious Material	5870 lbs

III. ACCEPTANCE PROCESS

The Department's overall concrete acceptance process includes a combination of acceptance sampling and testing, quality control sampling and testing, project verification testing, and quality assurance sampling and testing.

III.a. Acceptance Testing

Lot size(s) for material acceptance are established by the Contractor in accordance with Table B for the appropriate type of construction. Lots are established daily and are specific to a particular structural element. Daily placements of multiple structural elements may be combined if approved in writing by the Department prior to the placement.

Acceptance sampling locations are determined by the Department in accordance with PTM # 1. Acceptance samples are obtained at the point of placement.

If the test results from the plastic concrete for slump, air content, and temperature conform to specification requirements, acceptance cylinders are molded and standard cured (lime bath) for 28 days in accordance with PTM 611, Section 12.1.

A Lot of concrete is accepted when the 28-day acceptance cylinder results meet the Min. Mix Design Compressive Strengths in Table A **AND** when the 28-day QC compressive strength requirements have been met.

Additional acceptance and payment criteria for cylinders not meeting the 28-day Min. Mix Design Strengths are outlined in Pub.408/Section 110.10 but are administrative in nature and will not be covered as part of this course.

A higher class of concrete may be used in place of an indicated lower-class concrete if the higher-class concrete conforms to all the requirements of the indicated lower class, and if approved by the Department.

Note: The indicated lower class is the class required by the contract documents. Typically, the class is either shown in the plans or the specifications for the element to be constructed.

Table A
Cement Concrete Criteria

Class of Concrete	Use	Cement Factor ⁽²⁾⁽⁴⁾ (lbs./cu. yd.)		Maximum Water Cement Ratio ⁽⁵⁾ (lbs./lbs.)	Minimum Mix ^(1,7) Design Compressive Strength (psi)				28-Day Structural Design Compressive Strength (psi)
		Min.	Max.		Days				
					3	7	28 ⁽⁸⁾	56 ⁽⁸⁾	
AAAP	Bridge Deck	560	640	0.45	—	3,000	4,000	—	4,000
AAA ⁽³⁾	Other	634	752	0.43	—	3,600	4,500	—	4,000
AAAP LW	Bridge Deck	600	730	0.45	---	3,000	4,000	---	4,000
AA	Slip Form Paving	587	752	0.47	—	3,000	3,750	—	3,500
AA	Paving	587	752	0.47	—	3,000	3,750	—	3,500
AA	Accelerated ⁽⁶⁾	587	800	0.47	—	—	3,750	—	3,500
AA	Structures and Misc.	587	752	0.47	—	3,000	3,750	—	3,500
AA LW		587	752	0.47	---	3,000	3,750	---	3,000
ASC ⁽⁹⁾		587	846	0.47	---	---	4,000	---	4,000
A		564	752	0.50	—	2,750	3,300	—	3,000
C		394	658	0.66	—	1,500	2,000	—	2,000
HES		752	846	0.40	3,000	—	3,750	—	3,500

- (1) Test Procedures: Slump—AASHTO T 119; Compressive Strength—PTM No. 604, or Maturity Meter Method—PTM No. 640. The upper age limit and lower age limit are defined by the values listed for 7-day and 28-day compressive strength.
- (2) For use in miscellaneous or structural concrete, if the Fineness Modulus (FM) is between 2.3 and 2.5, increase the minimum cement factor for the class of concrete 47 pounds per cubic yard. This requirement may be waived after adequate strength data is available and analyzed according to the mix-design section in ACI 211.
- (3) AAA concrete is not allowed to be used for new bridge decks.
- (4) For exception, see Section 704.1(c). Cement factor may be increased to a maximum of 690 pounds per cubic yard with the approval of the DME/DMM.
- (5) If a portion of the cement is replaced by SCM, use a water to cement plus SCM ratio by weight. The minimum water cement ratio for AAAP is 0.40 pounds per pounds.
- (6) For accelerated cement concrete, submit mix design, as specified, Section 704.1(c), having a minimum target value compressive strength of 1,500 pounds per square inch at 7 hours if tested according to PTM No. 604. (1,500 pounds per square inch at 7 hours is for mix design acceptance only). The required compressive strength for opening to traffic is specified in Section 501.3(q).
- (7) Trial Mix Designs for Class AAAP, AAAP LW, ASC and all concrete paving mixtures are required to meet a minimum 28-day compressive strength overdesign requirement of 28-day Minimum Mix Design Compressive Strength plus 500 pounds per square inch.
- (8) DME/DMM may accept mix designs based on the 56-day strength based on qualification testing.
- (9) For accelerated structural cement concrete, submit mix design, as specified in Section 704.1(c), having a minimum target value compressive strength of 3,500 pounds per square inch at 24 hours and 3,000 pounds per square inch to open to traffic when tested according to PTM No. 604.

1. Density of Material. Except for admixtures, use the following material densities (unit weights) if proportioning cement concrete:

Pub. 408 / 2020 Initial addition effective April 10, 2020 specifications in Table "A" for Class AAAP Light weight concrete for bridge decks. A section also was added to Table "A" for Class AA Light weight concrete and Class ASC concrete under Structure and Miscellaneous use.

Class AAA is still listed in Table A but Note 3 clarifies that Class AAA is not permitted to be used for new bridge decks. Table A requirements for Class AAAP is 4000 psi for minimum mix design compressive strength and a maximum water cement ratio of 0.45.

The goal of Class A A A P is to increase resistance to chloride ion penetration and to reduce shrinkage potential while still exceeding compressive strength requirements.

Class AAAP cement concrete replaces Portland cement with pozzolan (silica fume or flyash or slag cement). Pozzolan is limited to not more than two of the three pozzolans in any one mix design.

1. Specification

704.1(d)5. Acceptance Testing. *Determine the lot size(s) for material acceptance according to Table B and notify the Representative. Establish new lots daily for each class of concrete. Lots must be specific to a particular structural element, except for incidental concrete items. The Contractor may use a lot combining structural elements if allowed in writing before concrete placement and if the following conditions are met:*

- *The total volume is 100 cubic yards or less.*
- *The combined structural elements are constructed using the same mix design concrete.*
- *The combined structural elements are cured using identical curing methods and conditions.*

Cylinders (and cores if necessary) for this lot will represent all the combined elements.

TABLE B
Maximum Lot Size for Concrete Acceptance

Construction Area	Maximum Lot Size
Structural Concrete	100 cu. yd.
Pavement Concrete	500 cu. yd.
Pavement Patching Concrete	200 cu. yd.
Incidental Concrete	100 cu. yd.

The Representative will select sample locations for acceptance testing according to PTM No. 1 (n=1). Perform sampling and testing for acceptance in the presence of the Representative. Obtain samples of fresh concrete at the point of placement according to PTM No. 601. Perform concrete temperature tests. Perform air content tests according to AASHTO T 196 or T 152. Reject all concrete not conforming to the specification requirements at the point of placement.

If the results of plastic concrete testing conform to the specification requirements, mold a sufficient number of acceptance cylinders according to PTM No. 611 from the same sample of concrete taken for slump, air content, and temperature determination. Standard cure acceptance cylinders according to PTM No. 611, Section 12.1, for 28 days and 56 days (AAAP and Prevention Level Z) at an acceptable location. Conduct 28-day and 56-day (AAAP and Prevention Level Z mixtures only) compressive strength testing of two acceptance cylinders according to PTM No. 604. If for any reason two testable acceptance cylinders are not available for compressive strength testing, obtain two cores of the representative concrete within 3 working days as directed, and at no additional cost to the Department. Conduct 28-day compressive strength testing of the cores according to PTM No. 604.

The Department will accept the lot of concrete if the average 28-day acceptance cylinder compressive strength test result is greater than or equal to the 28-day minimum mix design compressive strength specified in Table A and if the average 28-day QC compressive strength requirements specified in Section 704.1(d)4.b have been met.

If the average 28-day acceptance cylinder compressive strength test result is less than the 28-day minimum mix design compressive strength specified in Table A, acceptance of the concrete lot will be based on the procedures as specified in Section 110.10.

Note: Make sure to mold enough cylinders.

III.b. QC Cylinder Requirements

From the same sample of concrete selected for acceptance testing, QC cylinders must be molded and tested for 28-day compressive strength as part of the acceptance process.

In addition to the 28-day QC cylinders, from this same sample, it is the contractor's responsibility to mold a sufficient number of cylinders to be tested for 3-day, 7-day, 14-day (AAP) compressive strengths, form removal strengths, end of cure, loading strengths or any other special requirements as specified.

If using the maturity method to estimate concrete compressive strength, mold two or more cylindrical specimens for temperature history recording and embed a temperature sensor at the vertical and horizontal center of the cylindrical specimen and activate the maturity meter or data acquisition equipment to record the temperature history for the 3-day, 7-day, 14-day, 28-day, and, as required, 56-day compressive strength analysis.

Field cure cylinders for the specified curing period. QC cylinders are field cured and protected from the elements in the same manner as the structural element they represent until they are tested for compressive strength. After concrete curing is discontinued, QC cylinders may be relocated to a pre-approved, acceptable, secure area, to protect them from damage.

Handling and protection of field cured cylinders should be covered in detail in the contractor's QC plan. All QC sampling and testing must be witnessed by the Department's Representative.

1. 7-Day QC Compressive Strength

When the 7-day compressive strength is \geq the Table A 7-day minimum mix design compressive strength, field curing for the Lot represented by the cylinders may be discontinued.

If the 7-day strengths aren't met in 7-days, field curing must be continued for a maximum of 28 days or until the 28-day minimum mix design compressive strength has been met. It is the responsibility of the contractor to mold a sufficient number cylinders to test for cure removal between the 7th and 28th days to permit the removal of the curing before the 28th day should the 7-day breaks fail to meet strength requirements.

2. 28-Day QC Compressive Strength

If the 28-day QC compressive strength test results are \geq Table A 28-day minimum mix design strengths, acceptance of the lot is based on the acceptance cylinder results.

If the 28-day QC compressive strength test results are $<$ Table A 28-day minimum mix design strengths, but \geq the 28-day structural design compressive strength, acceptance of the lot is based on the acceptance cylinder results and an investigation of the sampling, testing, and curing procedures must be submitted to the Department for review and approval.

If the 28-day QC compressive strength test results are < the Table A 28-day structural design compressive strength, acceptance of the lot is based on core results as per Section 110.10(d).

III.c. Verification Testing

Verification testing is performed by a Department Representative as a competence check on the contractor's technician who is performing the acceptance testing. Using the same equipment, and testing the same sample of material, two certified technicians, Contractor and Department, should be able to provide similar test results.

Verification testing is performed in conjunction with the first acceptance test and once for every 10 acceptance tests thereafter for each type of concrete specified in Table B, not by class of concrete. Tests are performed for temperature, plastic air content and compressive strength. Cylinders are cured in the lime bath with the acceptance cylinders. **The Department Representative will conduct the testing of the 28-day verification cylinders compressive strength testing according to PTM 604.**

If the test results differ by more than 5 °F for temperature, 1.0% for plastic air content, or 500 psi for compressive strength, the Department will immediately review test procedures, equipment, and personnel used in the acceptance testing process and implement corrective measures to ensure tests meet the specified tolerances.

All verification test results and corrective actions are to be documented in the Concrete Inspector's Daily Record Book. Compressive strength results should be documented on the CS-458A.

1. Specification

704.1(d)6. Verification Testing. The Representative will perform verification testing on the initial acceptance sample for each type of concrete specified in Table B and a minimum of one verification test for every ten acceptance samples thereafter. Verification testing will consist of testing for temperature, air content, and compressive strength. Verification tests will be performed on concrete from the same sample used for acceptance testing.

The Representative will obtain the temperature of the sample concurrently with the acceptance sample. Immediately after an acceptable air content test result for acceptance is obtained, the Representative will test the sample for air content according to AASHTO T 196 or T 152 using the same air meter.

*The Representative will mold two verification cylinders according to PTM No. 611. Standard cure the verification cylinders along with the acceptance cylinders according to PTM No. 611, Section 12.1, for 28 days. **The Representative will conduct 28-day compressive strength testing of the verification cylinders according to PTM No. 604.** Conduct the testing at the same time the acceptance cylinders are tested and using the same equipment.*

Verification test results will be compared to the associated acceptance test results and will not be used to determine acceptance of the lot. If there is a difference in test results of more than 5F for temperature, 1.0% for air content, or 500 pounds per square inch for compressive strength,

the Representative will immediately review the testing procedures, equipment, and personnel used in the acceptance testing and implement corrective measures to ensure the tests are performed within the prescribed tolerances. The Representative will record the acceptance test results, the verification test results and applicable corrective measures in the Concrete Inspector's Daily Record Book, Form CS-472.

III.d. Quality Assurance/Independent Assurance Testing

The CMD Construction Quality Assurance Section conducts QA reviews randomly at concrete construction operations throughout the Commonwealth. Part of this review consists of an Independent Assurance evaluation of the acceptance testing process.

The IA process provides an independent check on the equipment used in the acceptance process by having technicians run tests on the same sample of material with two sets of equipment.

At the time of an acceptance or QC test, the Quality Assurance Representative will obtain a companion temperature of the concrete sample along with the technician's temperature. Also, after the contractor's technician runs the plastic air content test, the Quality Assurance Representative will run a second air content test from the same sample using a back-up air meter. If the test results differ by more than 5 °F for temperature or 1.0% for plastic air content, the Project will immediately review test procedures, equipment, and personnel used in the acceptance testing process and implement corrective measures to ensure tests meet the specified tolerances.

In addition to the temperature and air content results, Independent Assurance cylinders will be molded by the Quality Assurance Representative for testing at both the project and at LTS. This will provide a check on the compression machine used by the project for acceptance testing. These cylinders will be field cured along with the contractor's 28-day QC cylinders. If test results differ by more than 500 psi, test procedures, etc. will be reviewed and immediate action taken by the project as with the temperature and air content results.

All cylinders tested for QA/IA compressive strength must be tested to absolute refusal (failure) at the project to ensure an accurate comparison of the compression machines.

As with the verification test results, QA/IA test results and any required corrective actions are to be documented in the Concrete Inspector's Daily Record Book and on the CS- 458A.

1. Specification

704.1(d)7. QA Testing. *The CMD QA personnel will obtain QA samples as part of the operation review process according to the QA Manual, Publication 25.*

QA personnel will select concrete to be sampled. Obtain samples of fresh concrete at the point of placement according to PTM No. 601. Perform concrete temperature tests adjacent to those conducted by QA personnel. Perform air content tests according to AASHTO T 196 or T 152 with the air meter used for acceptance testing. QA personnel will perform air content tests according to AASHTO T 196 or T 152 with the backup air meter on the project. Immediately report all test results to the QA personnel. Reject all concrete not conforming to the specification requirements at the point of placement.

QA personnel will immediately perform an independent assurance evaluation of the temperature and air content test results. If the difference in test results is more than 5F for temperature or 1.0% for air content, the Representative will immediately review the testing procedures, equipment, and personnel used in the acceptance testing and implement corrective measures to ensure the tests are performed within the prescribed tolerances.

QA personnel will mold five QA cylinders from the selected sample according to PTM No. 611. Field cure the QA cylinders according to PTM No. 611, Section 12.2, for the specified curing period for the structural element the cylinders represent. After curing of the in-place concrete is discontinued, QA cylinders may be relocated to a pre-approved, acceptable, secure area, to protect them from damage. Provide maintenance and security for the area at no additional cost to the Department. The secure area must be easily accessible for inspection at all times. Continue to provide the same field cure and protection from the elements on all surfaces of the cylinders as that provided for the in-place concrete the cylinders represent until the cylinders are tested for 28-day compressive strength.

Conduct 28-day compressive strength testing on two QA cylinders according to PTM No. 604 using the same equipment used for acceptance and verification testing.

The Representative will forward the remaining three QA cylinders to the LTS for 28-day compressive strength testing according to PTM No. 604 and hardened air content testing according to PTM No. 623. Furnish packaging material and package cylinders under the direction and supervision of the Representative. Place the cylinders in individual containers cushioned with suitable material to prevent damage during shipment. The total weight of each container, cylinder and cushioning material must not exceed 50 pounds.

QA personnel will perform an independent assurance evaluation of the 28-day compressive strength test results. If the difference between the test results of the cylinders tested at the project site and the cylinders tested at the LTS is more than 500 pounds per square inch, the Representative will immediately review the testing procedures, equipment, and personnel used in the acceptance testing and implement corrective measures to ensure the tests are performed within the prescribed tolerances.

III.e. Section 501 – Concrete Pavements

Most day-to-day concrete placements on Department projects are accepted in accordance with Pub 408 Section 704. Section 501 for concrete pavement placements has slightly different acceptance requirements. During the 2020 Pub 408 Rewrite, changes occurred to adopt some of the concrete pavement requirements used for Section 530 Long Life Concrete Pavements for all pavements and are now contained in Section 501. Accelerated concrete pavement requirements were also moved from Section 516 Concrete Pavement Patching into Section 501 since accelerated concrete is often used at intersections and business entrances where there is a desire to open these early to traffic.

Section 501 revises some of the Section 704 concrete mix design requirements. For concrete paving mixes, Section 501 revised Section 704 Table A as follows:

Revise Section 704 **TABLE A – Cement Concrete Criteria** and referenced Notes to read as follows:

Class of Concrete	Use	Cement Factor (lbs./cu.yd.)		Water Cement Ratio ⁽¹⁾⁽²⁾		Minimum Mix Design Compressive Strength (psi)			Proportions Coarse Aggregate Solid Volume (cu.ft./cu.yd.)	28-Day Structural Design Compressive Strength (psi)
		Min.	Max.	Min.	Max.	3	7	28 ⁽³⁾		
AA	Slip Form Paving	517	611	0.37	0.42	—	3,000	4,000	—	3,500
AA	Form Paving	517	611	0.37	0.45	—	3,000	4,000	—	3,500
AA	Accelerated Paving ⁽⁴⁾	517	752	0.37	0.45	—	3,000	4,000	—	3,500
HES	Paving	517	752	0.37	0.42	2,000		4,000	—	3,500

- (1) Where the cement is replaced by supplementary cementitious material, use a water to cement plus supplementary cementitious material ratio by weight.
- (2) Lower Cement Factor can be permitted by DME/DMM if the mix design is demonstrated to perform adequately.
- (3) DME/DMM may accept mix designs based on the 56-day strength based on qualification testing.
- (4) For accelerated cement concrete, submit a mix design as specified in Section 704.1(c) having a minimum target value compressive strength of 1,500 pounds per square inch at 7 hours when tested according to PTM No. 604. The minimum required compressive strength for opening an accelerated strength pavement to traffic is 1,200 pounds per square inch as specified in Section 501.3(q).

Standard concrete pavement mix designs are required to use an optimized aggregate structure which allows the reduction of cement content and still maintain necessary strength and workability. An optimized aggregate structure is more uniformly graded than typical gap-graded mixes with AASHTO No. 57's and sand. Standard concrete pavement mix designs are tested for their resistance to chlorides and shrinkage cracking. Standard concrete pavement mix designs also limit the Water/Cement ratio to 0.42 for slip-form paving and 0.45 for formed paving.

Accelerated and High Early Strength (HES) pavement mix designs are encouraged but not required to use an optimized aggregate structure and are not required to be tested for resistance to chlorides or shrinkage cracking. Accelerated and HES mixes are only permitted to be used in pavements where indicated in the contract documents or where directed.

All concrete pavement mix designs are required to be designed with an air content of 7.0% \pm 1.5% (5.5% to 8.5%) in the plastic state.

QC and acceptance sampling and testing is similar to Section 704, however, a comprehensive QC Plan is required as specified in Section 501.3(a)1. Make sure there are enough QC cylinders molded to cover the Opening to Traffic requirements described later in this Section. In addition to the plastic air content discussed above, the frequency of testing may be reduced to a minimum of one set of tests every 50 cubic yards or 30 minutes, whichever is greater, once material control is established for concrete paving operations, as specified in Section 704.1(d)4.a.

Application of curing materials is required after finishing and texturing, and within 30 minutes of the dissipation of bleed water as specified in Section 501.3(l). The curing materials must be maintained until the pavement has achieved sufficient strength for opening to traffic as specified in Section 501.3(q). After removing forms and correcting honeycombed areas, cure the sides with the same method as the surface

Although Section 501.3(l) allows many options for curing materials, white, poly-alpha-methylstyrene (PAMS) liquid membrane forming curing compound is the only curing compound permitted on new pavements. Type 2 white pigmented liquid membrane forming curing compound is only permitted for pavement repairs and smaller applications.

For all accelerated strength concrete pavements, insulation or heating of pavements is now required during the curing operation. The curing temperature must be controlled and monitored at least hourly to ensure that the concrete pavement does not experience a curing temperature change more than 40F within any 1-hour period during the curing operation. If a change in curing temperature more than 40F occurs in the concrete pavement within any 1-hour period, the work will be considered defective.

Opening to Traffic concrete QC cylinders must be molded from the same sample of concrete selected for acceptance testing as specified in Section 704.1(d)5. Make sure to mold enough concrete QC cylinders to be tested for opening to traffic compressive strength testing. In addition, mold enough concrete QC cylinders from the last mixer load of the day for opening to traffic compressive strength testing of accelerated strength pavements.

For normal strength pavements, cure the QC cylinders as specified in Section 704.1(d)4.b. The Representative will determine when pavement may be opened to traffic based on when the concrete attains the minimum required compressive strength according to Table D.

Table D

Slab Thick, inches	Strength for Opening to Traffic, psi			
	Slab Length < 10 ft		Slab Length \geq 10 ft	
	f'c	MR (3rd)	f'c	MR (3rd)
6.0	3000	490	3600	540
7.0	2400	370	2700	410
8.0	2150	340	2150	340
9.0	2000	275	2000	300
10.0 +	2000	250	2000	300

For accelerated strength pavements, cure the QC cylinders as specified in Section 501.3(1). The Representative will determine when the accelerated strength pavement may be opened to traffic based on when the concrete attains the minimum required compressive strength of 1,200 pounds per square inch.

Pavement opened to traffic before meeting the required compressive strength will be considered defective work and is required to be Removed and Replaced as specified in Section 501.3(t). If not removed and replaced, continue testing cylinders for compressive strength until the 28-day minimum mix design compressive strength specified in Section 501.2(a) Table A is attained or for a maximum of 56 days.

As with standard concrete placements, Field Verification and Quality Assurance testing will also be performed and recorded.

Accelerated Concrete Paving Mix Design Requirements – SOL 481-21-01

During the 2020 Pub 408 Rewrite, different groups implemented changes to Section 501 and Section 704 which created some conflicts between the specifications. SOL 481-21-01 was issued to avoid the mix design conflicts. Section 704 mix design requirements for accelerated concrete paving mixtures are to be followed until the specifications are aligned.

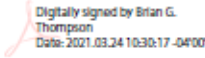
	
481-21-01	
DATE:	March 24, 2021
SUBJECT:	Class AA Accelerated Paving Mixture Design Requirements
TO:	District Executives Assistant District Executives - Construction
FROM:	Brian G. Thompson, P.E. Brian G. Thompson Bureau of Project Delivery Director
	 <small>Digitally signed by Brian G. Thompson Date: 2021.03.24 10:30:17 -0400</small>
<p>This Strike-Off Letter (SOL) is time and cost neutral. The purpose of this SOL is to address the discrepancies between Section 501 and Section 704, in Publication 408, regarding Class AA Accelerated Paving mixture design requirements.</p> <p>Changes were made to the 2020 Initial Edition of Publication 408, Section 501.2(b) Class AA Cement Concrete, Accelerated, Modified, and Table A – Cement Concrete Criteria. These changes created a discrepancy between Section 501 and Section 704. To avoid confusion during the mix design process, Section 704 mixture design requirements should be followed for Class AA Cement Concrete, Accelerated. A Clearance Transmittal will be issued in the future to address these discrepancies and align the two specification sections.</p> <p>This change is effective immediately.</p> <p>Should you require additional information, please contact Patricia Baer, Concrete, Aggregate, Cement, and Soils Lab Unit Manager, at 717.787.2489 or at patrbaer@pa.gov.</p> <p>4814/PIB/mse</p> <p>cc: Deputy Secretary Reading File Highway Administration Bureau Directors Bureau of Project Delivery Division Chiefs Joseph Robinson, P.E., Bureau of Project Delivery Brent Trivelpiece, Bureau of Project Delivery Timothy Ramirez, P.E., Bureau of Project Delivery Patricia Baer, Bureau of Project Delivery District Materials Engineers/Managers Federal Highway Administration Associated Pennsylvania Constructors Pennsylvania Turnpike Commission</p> <hr/> <p style="text-align: center;"><small>Bureau of Project Delivery 400 North Street, 7th Floor Harrisburg, PA 17120 717.787.9730 www.penndot.gov</small></p>	

III.f. Section 506 – RPS Cement Concrete Pavements

Section 506 for RPS concrete pavements is sometimes used on large mainline paving projects, typically interstate or interstate look-alike construction or reconstruction. The quantity of concrete involved is very large and the acceptance testing frequencies specified in Section 704 are not practical.

RPS concrete pavement acceptance is determined using a statistical analysis of the combined pavement characteristics of depth, strength, and plastic air content based on the full width of the pavement placement. For this course, we will consider only the testing parameters that affect the concrete technician performing the acceptance and QC testing.

As with all acceptance testing, the samples for acceptance must be obtained at the point of placement. Typically, this is from a pile of concrete placed on the grade in front of the paver. It is recommended that QC tests be taken at a mutually agreeable location so as not to impede the progress of the paving operation and results can be obtained prior to placement, when practical.

A comprehensive QC Plan must be submitted and approved by the Department in accordance with Section 106.03(a)1. This comprehensive QC Plan is to address all concrete plant production and placement quality control measures, including action points, corrective actions, and rejection points, that are associated with constructing an RPS concrete pavement to assure compliance with the requirements of Pub. 408 Section 506. Therefore, a QC Plan as outlined on Form CS-704 is insufficient. Once material control has been established, as specified in Section 704.1(d)4.a and discussed earlier in this course, the frequency of control testing may be reduced to a minimum of one set of tests for every 50 CY or 30 minutes, whichever is greater. This is in accordance with Section 501.2.

RPS concrete acceptance lots consist of 5,600 SY of continuously placed concrete pavement, of a consistent depth, divided into four equal sublots of 1,400 SY each. The Department will determine the acceptance test locations. For each sublot, a test for plastic air content, compressive strength and depth will be taken. These test results will then be statistically analyzed as per the specifications and a payment percentage for each lot will be established. Although details of this process are not covered by this course, the Multiple Characteristic Formula used to determine payment for each Lot is:

$$L_p = C_p \left[\frac{(2P_s + 2P_d + P_a)}{500} \right]$$

where:

- L_p = Lot Payment
- C_p = Contract price per lot (contract price times lot size)
- P_s = Characteristic Percentage of Compressive Strength—(Table B)
- P_d = Characteristic Percentage for Depth—(Table A)
- P_a = Characteristic Percentage for Air Content—(Table B)

As with standard concrete placements, Field Verification and Quality Assurance testing will also be performed and recorded.

III.g. Section 530 – Long-Life Concrete Pavements (LLCP)

Long-Life Concrete Pavement (LLCP) specifications require higher quality materials than our standard Sections 501 and 506 specifications. Similar to Section 506 RPS Concrete Pavements, LLCP specifications are used on large mainline paving projects where the quantity of concrete involved is very large and the acceptance testing frequencies specified in Section 704 are not practical.

Similar to Section 501, LLCP mix designs are required to use an optimized aggregate structure which allows the reduction of cement content and still maintain necessary strength and workability. LLCP mix designs are tested for their resistance to chlorides and shrinkage cracking. LLCP mix designs also limit the Cement Factor to 611 pounds per cubic yard and the Water/Cement ratio to 0.42. High Early Strength mix designs are prohibited for LLCP.

QC and acceptance sampling and testing is similar to Section 506 RPS Concrete Pavements. Some of the differences are as follows:

The comprehensive QC Plan is required by Section 530.3(a)1 to include corrective actions when the concrete temperatures exceed 80 °F. The QC Plan is to require the 1st load to be tested for plastic air content and to reject any load not meeting an air content of $7\% \pm 1.5\%$ (5.5% to 8.5%). After a failing air content, the next 3 loads are to be tested. Once material control has been established, the frequency of control testing may be reduced to a minimum of one set of tests every 50 cubic yards or 30 minutes, whichever is greater, in accordance with Section 501.2.

Unlike Section 506 RPS Concrete Pavements, LLCP concrete pavement acceptance does not include plastic air content results in the statistical analysis of the combined pavement characteristics, only depth and strength. On some projects, Water/Cement ratio is included.

III.h. Accelerated Concrete for Patching

Accelerated strength concrete mixes for patching has become very much the norm for pavement rehabilitation in high traffic urban areas. These mixes contain an accelerant additive to gain early strength for opening the roadway to traffic within a given time frame.

As previously discussed in Section 501, accelerated strength concrete patches require special consideration with regards to curing temperatures and opening to traffic strengths. Read contract special provisions carefully to ensure all requirements are being met as conditions differ statewide.

Apply curing materials after finishing and texturing, and within 30 minutes of the dissipation of bleed water as specified in Section 516.3(j). Maintain the curing materials until the pavement has achieved sufficient strength for opening to traffic as specified in Section 501.3(q). After removing forms and correcting honeycombed areas, cure the sides with the same method as the surface.

Accelerated strength concrete patches must meet a minimum compressive strength of 1,200 psi at the time of **opening to traffic**. As a minimum, opening to traffic QC cylinders must be molded in addition to the acceptance cylinders for the lot of concrete placed AND from the last load of concrete placed for the day.

The contractor's QC Plan should provide additional detail as to the number of cylinders molded and the disposition of these cylinders to ensure the roadway opens once the Minimum compressive strength is achieved and is only considered to be defective if the concrete is open to traffic prior to achieving the minimum 1,200 psi compressive strength requirement.

Acceptance and payment for accelerated strength concrete patches is based on 28-day acceptance and on 28-day QC compressive strengths on a lot-by-lot basis the same as for normal strength concrete patches. This should not be confused with "opening to traffic" strengths. As discussed above, accelerated strength concrete patches opened to traffic prior to achieving the minimum 1,200 psi compressive strength will be considered defective and are required to be Removed and Replaced. If not removed and replaced, continue testing cylinders for compressive strength until the 28-day minimum mix design compressive strength is attained or for a maximum of 56 days.

AT Cylinder Testing

- Daily Lots and every 200 CY or fraction thereof
- 28-day AT & QC cylinders are also required for acceptance
 - Except for Opening to Traffic failures removed and replaced

III.i. Placing Concrete in Water

There are times when placing concrete for foundations, the concrete will be placed in extremely wet conditions or sometimes under water. To compensate for this condition, Section 1001.3(k)3 requires concrete placed in water > 1 inch to contain an Anti-Washout Admixture (AWA) unless otherwise approved by the DME/DMM based on a case specific justification. If the use of an AWA is waived by the DME/DMM, the use of 25% more cement or cementitious material than the quantity specified for the class of concrete being used is required. Drilled shafts and caissons are exempt from these requirements since they have their own separate requirements.

Detailed requirements for placing concrete under water are defined in Section 1001.3(k)3 and are outlined below. Of specific importance is paragraph #7, **“Do not begin concrete placement until the placement procedures, concrete mix design, inspection procedures, and concrete sampling procedures have been accepted by the Representative.”** Details for an underwater concrete placement should be clearly defined in the contractor’s QC Plan and reviewed at the pre-placement meeting.

When placing concrete in water, **the water must have a temperature $\geq 40^{\circ}$ F** whether using a mix with an AWA or extra cement.

1. Anti-Washout Admixture (AWA)

Anti-Washout Admixtures are designed to keep most of the cement paste from washing out of the concrete mix when it comes in contact with water. Test method PTM No. 641 was created to determine the amount of cement paste loss in water. This test is conducted at the plant and a mix design requirement.

When a mix with an AWA is placed below the frost line, it does not need to be air-entrained. If placed above the frost line, the mix is required to have an air content between 4.5% and 7.5% like most other mixes.

The maximum slump of a mix with an AWA is 8 inches.

The cost of the AWA is a separate pay item in Section 1001.4(i).

2. +25% Extra Cement Concrete

The use of 25% more cement mixes to mitigate foundations with water has been employed for years. Although mixes with an AWA is now preferred, 25% more cement mixes is still an option as some plants do not have designs with an AWA.

The maximum slump of a mix with 25% more cement is 2.5 inches. The air content acceptance criteria of 4.5% to 7.5% are not waived for extra cement concrete regardless of its structural use or location.

POM B/7/21 further outlines the Department’s procedures for calculating the extra cement or cementitious material in a given mix. These details are not going to be covered by this

course as this is something that is normally done at the plant prior to arrival on the project. For your information, POM B/7/21 is included in this manual. Field personnel need to be sure they have an approved design for this condition.

3. Specification

1001.3(k)3. Placing Concrete in Water.

3.a General. *When the depth of water in the foundation area is less than 1 inch, no adjustments to the specified class of concrete are required. When there is greater than 1 inch of water in the foundation, utilize an anti-washout admixture (AWA) as specified below unless otherwise approved by the DME/DMM based on a case specific justification. If use of the AWA is waived by the Representative, provide concrete with a 2.5 inch maximum slump and add 25% more cement than the quantity specified for the concrete class being used, as specified in Section 704.1(h).*

Drilled shafts and caissons are exempt from this requirement. Do not deposit concrete in water having a temperature below 40F.

Utilize a mix design using an AWA to achieve a loss no more than 8.0% as determined by PTM No. 641.

If concrete with an AWA is placed below the frost line no air entrainment is required in the concrete mix design.

When concrete is placed above the frost line, design concrete to have an air content of 6.0%. Accept concrete at point of placement with an air content between 4.5% and 7.5%.

Limit the slump at point of placement to no more than 8.0 inches.

Hold a concrete placement meeting and present details of the placement to the Representative. Do not begin concrete placement until the placement procedures, concrete mix design, inspection procedures, and concrete sampling procedures have been accepted by the Representative.

If the tremie method is selected for placing concrete, submit a concrete placement procedure plan for approval at least 21 calendar days before performing the work, and include the following:

- *Concrete mix design.*
- *Available concrete production capability.*
- *Availability and capacity of equipment to be used to transfer concrete to the tremie.*
- *The total volume of concrete to be placed.*
- *The various placement schemes available.*
- *Tremie locations.*
- *Maximum flow distance of concrete.*
- *Any restrictions to flow, such as reinforcing steel, piles, and internal form bracing.*
- *The method of sealing the tremies and the emergency restart procedure if the seal is broken.*
- *An inspection plan detailing sounding locations and the frequency of soundings. Take soundings over the entire placement area on, at least, an hourly basis.*
- *A concrete sampling and testing plan.*

REPLACES B.7.21	PENNSYLVANIA DEPARTMENT OF TRANSPORTATION PROJECT OFFICE MANUAL	PART B	SECTION 7	PAGE 21-1
DATED 04/01/2017		DATE April 1, 2020		
SUBJECT EXTRA CEMENT CONCRETE				

Publication 408, Section 1001.3(k)3.a, provides for the use of 25% more cement than the quantity specified for the concrete class being used on an exception basis if approved by the District Materials Manager/District Materials Engineer (DMM/DME). This is specifically for concrete placements made in or under water.

The extra cement is actually considered cementitious material including fly ash, slag cement, and silica fume. These replacements can be made in the same proportions as established in the master mix design being used.

When extra cement (cementitious material) is added to the load, some additional water may be added to the mix, not to exceed the maximum water/cement ratio for the class of concrete specified. Maximum allowable extra water is calculated as follows:

$$E = 0.5 \times A \times \frac{W}{(C + P)}$$

Where:

- E = extra weight of water
- W = total weight of water in design
- C = total weight of cement in design
- P = total weight of supplemental cementitious material (fly ash, slag cement, or silica fume) in design
- A = extra cementitious weight

The intent is to put up to one-half of the water normally used for this additional weight of cementitious material in this mix in order to provide a stiffer paste which will be more resistant to scour and compensate for eventual loss or dilution of paste by water. By specification, the maximum allowable slump for use in the field under this condition is 2 ½ inches.

An Air Entrainment Agent (AEA) is normally dosed based on 100 lbs. of cement, but can be varied due to conditions such as ambient temperature and haul time. Therefore, additional AEAs will most likely have to be added to compensate for the extra cement in order to have plastic air content within specification for field placement. Acceptance criteria for plastic air content are not waived for extra cement concrete regardless of its structural use or location.

This procedure will increase the volume of concrete and should be considered by the inspector if computing yield and by the contractor when calculating and ordering concrete in a placement. A separate mix design is not necessary unless required by the DMM/DME.

REPLACES C.10.11	PENNSYLVANIA DEPARTMENT OF TRANSPORTATION	PART C	SECTION 10	PAGE 11-1
DATED 04/01/2017	PROJECT OFFICE MANUAL	DATE April 1, 2021		
SUBJECT PLACEMENT OF EXTRA CEMENT CONCRETE IN WATER				

Publication 408, Section 1001.3(k)3.a, provides for the use of 25% more cement than the quantity specified for the concrete class being used on an exception basis if approved by the District Materials Manager/District Materials Engineer (DMM/DME). This is specifically for concrete placements made in or under water. The extra cement is added to the mix to stiffen or thicken the paste content to make it more resistant to scour and compensate for paste loss that will occur when placing concrete in water. When water is present, it should be reasonably still to minimize water's negative effect and loss of paste.

Placing concrete in water is not the preferred condition. Prior to the Inspector authorizing a Contractor to place concrete in water, the Contractor must make a valid effort to first dewater the site by use of pumps (in sufficient quantity and capacity), sealing the forms, diversion of the stream, or other legitimate effort. Only after these attempts have failed to adequately stem the flow of water should the Contractor be permitted to place in water. Any pump discharge containing cement paste must be controlled to prevent discharge into any waterway.

Water is added at the plant to compensate for the slump loss that would be anticipated with the addition of the extra cement; however, when placing concrete with extra cement, the maximum slump permitted at the point of placement is 2½ inches. Extra air entraining admixture is also added to the load to compensate for the extra cement. There is no relaxation of plastic air content or slump specifications as many such placements are structural elements that require durable concrete.

Ideally, place extra cement concrete to a level just above the surface of the water (about 2 inches). When making placements in water, first place concrete to seal off the flow of water and then, if possible, purge water by placing concrete on top of previous deposits to attempt to eliminate pockets of mud/water being trapped in the placement. Loads of extra cement concrete and conventional loads may be alternated if approved by the DMM/DME and if the conventional concrete is not being placed in more than 2 inches of water.

For purposes of acceptance testing of the concrete (by compressive strength), do not test any extra cement concrete loads unless at least 50% of the lot is comprised of extra cement concrete. If random selection determines a load of extra cement concrete be tested for acceptance, either select the next conventional load of concrete for testing or select an alternate load according to PTM No. 1. Slump tests should still be performed for quality control purposes. Plastic air content should still be performed for quality control and acceptance purposes.

This procedure will increase the volume of concrete. The increased volume should be considered by the Inspector if computing yield and by the Contractor when calculating and ordering concrete in a placement. A separate mix design is not necessary unless required by the DMM/DME.

III.j Pumping Concrete

Section 1001.3(k)4.a provides a specification for the concrete pump and reduction device. Section 1001.3(k)4.b specifies the procedure and criteria for the determination of the QC and acceptance testing location when pumping concrete.

1. Determining QC and Acceptance Testing Location

The location of the QC sampling and acceptance sampling will be determined **Daily** on the first load of concrete and for **every 200 cubic yards thereafter**, by the following procedure:

Provide a concrete mixture in conformance with specification requirements in Section 704 for slump, air content, and temperature before placement into the pump.

Obtain a sample of concrete before placement in the pump and perform slump and air content tests.

Position the pump into the most severe vertical drop boom configuration, or, when pumping from the same elevation as the placement, at the longest horizontal section configuration that will occur during placement. Be sure to purge all grout material from the lines before obtaining a sample.

Obtain a sample of concrete at the discharge end of the pump and perform slump and air content tests.

If the test results for slump and air content taken at the discharge end of the pump are within ± 1.0 inch of the slump and $\pm 1.0\%$ of the air content taken before placement into the pump, QC and acceptance testing may be performed before placement into the pump.

If test results are **not** within the above tolerances, **acceptance testing** will be performed at the discharge end of the pump.

The **Representative** may require acceptance testing and QC testing to be performed at the point of placement at any time the quality of the material comes into question.

If more than one pump is utilized during placement, each pump must comply with the above procedure.

III.k Self-Consolidating Concrete (SCC)

Self-Consolidating Concrete (SCC) is a self-leveling mix that needs no consolidation with vibrators. It is widely used in precast concrete plants and used in the construction of drilled caissons in some Districts. For the purpose of this course, the SCC-related requirements contained in the Pub 408 Section 1006 for Drilled Caissons.

SCC mix designs are required to meet Class A Cement Concrete with some modifications. SCC mix designs limit the Water/Cement ratio to 0.45. The plastic air content requirements for SCC mixes are $6.5\% \pm 1.5\%$ (5.0% to 8.0%).

SCC use admixtures which enable the mix to flow and still maintain stability (cohesion of aggregate and cement). High-range water reducers (HRWR) and/or viscosity-modifying admixtures (VMA) may be added in the field. The addition of these admixtures in the field is to be detailed in the QC Plan.

Section 704 QC and acceptance sampling and testing is the same for SCC. In lieu of slump, slump flow, J-ring (passing ability) and visual stability index (VSI) are determined for SCC mixtures. The slump flow and VSI are determined in accordance with ASTM C1611. The slump flow is required between 20 to 30 inches. A $VSI \leq 1$ is also required (see illustrations below). The J-ring is tested in accordance with ASTM C1621 and required ≤ 2 inches of the slump flow result. Action points and corrective actions for the slump flow, J-ring and VSI should be detailed in the QC Plan.

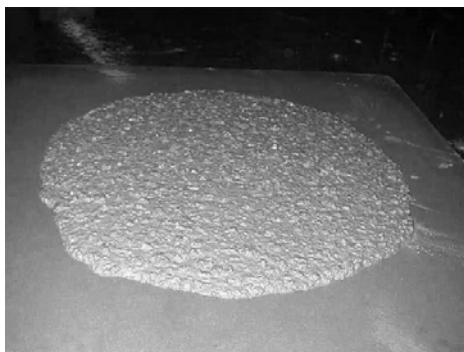

VSI = 0; Homogeneous, no bleeding



VSI = 1; Slight bleeding



VSI = 2; Mortar halo, slight segregation

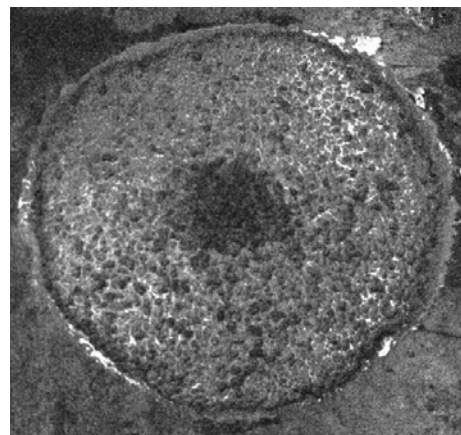

VSI = 3; Segregation

III.1. Latex Modified Concrete or Mortar

Latex modified concrete or mortar is used as a one course wearing surface for in-service bridge decks. Latex Mortar is specified for depths less than 1 ¼ inches and Latex Concrete is specified for depths 1 ¼ inches and greater.

The Department generically refers to both as “Latex”. Most of the general requirements for latex are the same for normal concrete. A Minimum Quality Control Plan for Field Placement of Latex Modified Mortar or Concrete Wearing Surface (CS-1042) is required, the contractor must provide all the test equipment, approved mix designs are required, calibrated mobile mixers are used, and the Department must witness all testing. The supplier of the latex should make satisfactory arrangements with the Representative at least 7 calendar days in advance of calibration. Mobile mixers must be calibrated by the supplier and witnessed by the Department in advance of the placement. They must be re-calibrated for every 100 CY of production per unit or as directed. They must be re-calibrated if aggregate sources are changed. Calibrated platform scales must be provided. This specification is covered in detail in 408/1042. Calibration forms and the procedures are located in Pub 19 Field Test Manual in PTM No. 637.

Due to the initial liquid nature of latex, the slump test cannot be performed immediately. The sample for slump must be discharged from the mixer and transported to a location unaffected by vibration and remain undisturbed for five minutes. The material is then remixed and tested for slump. The acceptance range for mortar is 4” to 6” and for concrete is 3” to 7”.

Plastic air content can be tested with a pressure meter and the acceptance range is 1% to 7%. A second sample container/wheelbarrow is recommended for air content testing and for cylinders due to the five-minute wait to perform the slump test. These tests can be completed while waiting to test for slump.

Cylinders are to be cured in accordance with Table A as shown below. The initial wet cure time is 48 hours +/- 2 hours followed by a dry curing period of 3 or 4 days.

TABLE A
Curing Times and Application of Live Load

Overlay Type	Depth	Water Cure (hours)	Dry Cure (hours)	Live Load Application Total Cure Time MIN (hours)	Live Load Application Comp. Strength MIN (psi)
LMM or LMC	≤ 2 inches	48	72	120	3,000
	> 2 inches	48	96	144	3,000
Accelerated LMC, 3 Hour	All	3	None	3	3,000
Accelerated LMC, 12 Hour	All	12	None	12	3,000

Quality Control and Acceptance testing requirements are specified in Section 1042. As stated earlier, a quality control plan is required. QC testing is required at 5 CY increments for slump, plastic air content, and temperature until control is established. The Department will witness the testing.

Latex will be accepted on a lot-by-lot basis. Each lot will consist of 20 CY or a day's placement, whichever is less. Testing will be performed for plastic air content, temperature, and compressive strength. Cylinders must meet compressive strength requirements in Table A at 5 days. No additional testing is required beyond 5 days. Live loads may be applied after the end of the period specified in Table A, (5 days for < 2", 6 days for > 2") and when the latex has achieved the minimum strength (3,000 psi) specified in Table A.

Latex is to be placed with a plastic latex mixture temperature between 50F and 85F. When ambient air temperatures are above 80 degrees at any time 24 hours before the placement the mix components must be mitigated.

Note: Section 1042.3(f)3.b states that compressive strength cylinder molds of 4-inch diameter by 8-inch height may be substituted for cylinder molds of 6-inch diameter by 12-inch height.

III.m. ACCEPTANCE OF SMALL QUANTITIES OF MATERIALS

P.O.M. B/6/6 states the Department's policy for Acceptance of Small Quantities of Portland Cement Concrete. The contractor must provide a comprehensive QC Plan (CS-704) covering the Acceptance of Small Quantities of Materials.

Reduced inspection and acceptance procedures are permitted only for relatively small quantities of material for which standard procedures would be too costly. Specifications are not to be waived nor are materials of lower quality to be accepted.

The Contractor shall be informed by the District at the preconstruction conference of the circumstances under which this acceptance procedure will be used.

1. POM B.6.6

PORTLAND CEMENT CONCRETE ---

Less than 25 cu. yd. per day per class of concrete for non-critical incidental items.

This procedure is not permitted for structures of any type; mainline, shoulders, and ramp paving; or other structurally critical items which may carry traffic loads.

Items that are non-critical may be included in this procedure. Some of the incidental items for which reduced inspection control may be used include:

- *Paved Ditch*
- *Curb and Gutter*
- *Curb Cuts*
- *Raised Medians*
- *Pipe Headwalls*
- *Inlets*
- *Base Course Widening*
- *Sidewalks*
- *Fence Posts*

- *Guide Rail Anchors*
- *Sign Bases (Except Overhead Structure Foundations)*

The requirement for molding cylinders may be waived when small quantities acceptance is utilized. However, it is recommended that Quality Control (QC) tests for slump, plastic air and temperature are performed.

If the total quantity of Portland Cement Concrete for a contract line item exceeds 100 cubic yards, at least one set of AT cylinders shall be molded during one of the daily placements for acceptance of that day's material.

It is recommended that this policy is discussed at the Preconstruction meeting held for the project. Acceptance of small quantities of Portland Cement Concrete must be detailed in the Contractor's QC plan.

The Contractor will furnish the Department daily, from the material producer, a Form CS-4171 certifying that the material was produced in accordance with the approved mix design and PennDOT specifications.

Review Questions

III. Acceptance Process

1. The Department's concrete acceptance process includes sampling and testing for acceptance, quality control, verification and quality assurance. True / False
2. Acceptance sample locations are determined by the Department in accordance with PTM #1. True / False
3. Acceptance lots must be specific to each structural element unless requested in writing to combine. True / False
4. When a higher class of concrete is used in place of an indicated lower class (contractor elects to place Class AA instead of Class A which was indicated), the concrete placed must meet all specification requirements of the indicated class.
True / False
5. When the lime-bath Acceptance cylinders are tested at 28 days and meet the 28-day minimum design compressive strengths in Table A, the concrete is accepted for 100% payment. True / False
6. If the 7-day QC cylinder compressive strength is not met in 7 days, curing must be continued until _____ or _____.
7. It is the responsibility of the _____ to ensure a sufficient number of QC cylinders are molded to satisfy all specification requirements for cure removal, opening to traffic, form removal, etc.
8. When QC cylinders meet the 28-day minimum design compressive strengths in Table A, the concrete is accepted and no additional testing for compressive strength is required. True / False
9. Verification testing is performed by _____ using concrete from the same sample of material and with the same equipment used for acceptance testing.
10. Verification testing will consist of testing for _____, _____, and _____ on the initial acceptance sample for each type of concrete specified in Section 704 Table B and a minimum of one for every ten acceptance tests thereafter.

Review Questions – cont'd

III. Acceptance Process

11. Quality Assurance testing on a project for temperature and air content provides a check on the equipment used in the acceptance process by having the concrete technician and QA representative run tests on two sets of equipment from the same sample of concrete. True / False
12. When Verification or QA/IA compressive strength testing is performed, all cylinders must be tested to absolute failure at the project. True / False
13. Accelerated concrete patches must meet a minimum compressive strength of _____ psi at the time of opening to traffic or it will be considered defective and must be removed and replaced.
14. Minimum "opening to traffic" QC cylinders for accelerated strength pavements or patches are required every ____ cubic yards or fraction thereof and from the final load placed.
15. When placing concrete in extremely wet conditions or under water, the concrete mix must contain _____ or _____.
16. When placing concrete in water, the water must have a temperature \geq _____ ° F.
17. After material control has been established, the frequency of QC testing for Section 506 RPS and Section 530 Long-Life concrete pavements may be reduced to a minimum of one test every _____.
18. For Latex Concrete or Mortar, mobile mixers must be calibrated by the supplier and witnessed by the Representative in advance of the placement and must be re-calibrated if aggregate sources change and for every 100 cubic yards of production per unit or as directed. True / False
19. If the test results for slump and air content taken at the discharge end of the pump are within ± 1.0 inch of the slump and $\pm 1.0\%$ of the air content taken before the pump, QC and acceptance testing may be performed before the pump. True / False
20. For small quantities of concrete that have a contract line item that exceeds 100 cubic yards, at least one set of AT cylinders is molded during one of the daily placements for acceptance of that day's material. True / False

IV. PENNDOT Concrete Testing Procedures

In 2003, PennDOT revised Publication 19 – Field and Lab Test Manual. Many of the Pennsylvania Test Methods (P.T.M.’s) referenced in the Pub. 408 specifications were eliminated or revised for the sampling and testing of plastic concrete. Many of the PTM’s that were eliminated were replaced with American Association of State, Highway, and Transportation Officials (AASHTO) standards. Some PTM’s were revised and only minor revisions to the AASHTO standards were incorporated. This section provides a brief review of the current sampling and testing procedures specified in the acceptance and quality control processes of the Pennsylvania Concrete Certification Testing Program. The applicable PTM modifications are included in this section of the manual.

American Society for Testing & Materials (ASTM) standards for sampling and testing plastic concrete in the field for acceptance are the standards used by ACI to certify concrete field testing technicians. Unless otherwise noted, AASHTO procedures are identical to ASTM procedures. A brief outline of the differences for each test procedure is also offered in this section.

IV.a. Slump - AASHTO T-119 Slump of Hydraulic Cement Concrete

The ASTM Designation is C143.

IV.b. Air Content, Pressure Method – AASHTO T-152 Air Content of Freshly Mixed Concrete by the Pressure Method

The ASTM Designation is C231.

This is the plastic air content test to be used for stone and gravel concrete mixes.

As per Pub. 408 Section 704.1(c)3, **“DO NOT APPLY AN AGGREGATE CORRECTION FACTOR.”** The Department has determined that the aggregate correction factor has a negligible effect on the plastic air content and is not to be applied in the determination of the plastic air content.

IV.c. Air Content, Volumetric Method – AASHTO T-196 Air Content of Freshly Mixed Concrete by the Volumetric Method

The ASTM Designation is C173.

This is the plastic air content test to be used for slag coarse aggregate and lightweight aggregate concrete mixes.

As per Pub. 408 Section 704.1(c)3, **“DO NOT APPLY AN AGGREGATE CORRECTION FACTOR.”** The Department has determined that the aggregate correction factor has a negligible effect on the plastic air content and is not to be applied in the determination of the plastic air content.

Volumetric air content testing is not routinely performed on a daily basis for concrete mixes in Pennsylvania. A thorough review of this test method is recommended prior to beginning any actual field testing.

IV.d. Density (Unit Weight), Yield, and Air Content of Concrete (Gravimetric) – AASHTO T-121

The ASTM Designation is C138.

These tests are more commonly used as quality control measures by the contractor or producer and are not a part of the formal acceptance process. It should be noted that now that the AASHTO test method has been adopted, the previous exception in PTM 613 that did not permit the use of an air meter bowl as the measuring vessel for the unit weight test is no longer in effect and **an air meter bowl is permitted.**

This test method also provides a method of determining the plastic air content of a concrete mix when an air meter is not available to run a test in accordance with AASHTO T-152.

IV.e. Temperature – ASTM C1064

The Department specifies in Section 704.1(d)4.a that concrete temperatures are to be taken in accordance with ASTM C1064 **Standard Test Method for Temperature of Freshly Mixed Hydraulic-Cement Concrete.**

The temperature of plastic concrete influences the quality, set time and strength development of the product. The overall quality of concrete will be decreased when there is a high initial temperature. High early breaks may be achieved, but lower than normal strengths will be recorded later. The temperature will help determine the curing method and protection needed for the structure and the duration of the cure.

Thermometers used in the acceptance process must meet the requirements of the ASTM C1064 standard. The thermometer calibration procedure is also outlined in the ASTM C1064 standard. The standard does not recognize the use of infrared thermometers in the acceptance process.

IV.f. Sampling Concrete – P.T.M. 601 Sampling Fresh Concrete

PTM 601 is the Pennsylvania Test Method for Sampling Fresh Concrete. **AASHTO R- 60 has been modified** by this PTM with respect to Section 5.2.4 - Sampling from Revolving Drum Truck Mixers or Agitators.

5. Procedure

5.2.4 Sampling from Revolving Drum Truck Mixers or Agitators – The sample shall be taken from the first one-third of the batch and subsequent portions if required, except that samples shall not be taken at the beginning or end of the discharge. Sampling shall be done by repeatedly passing a receptacle through the entire discharge stream, or by diverting the stream completely so that it discharges into a container. The rate of discharge of the batch shall be regulated by the rate of revolution of the drum, and not by the size of the gate opening. The slump and air content of the concrete shall be determined before one-third of the batch has been placed.

The remainder of AASHTO R-60 remains valid.

Before we can test concrete, it is important that we obtain a representative sample of the material while at the same time minimizing the possibility of non-specification material being incorporated into the structure or pavement. All standards prohibit sampling from the initial concrete discharge from the truck. By sampling from the 1st 1/3 of the truck rather than 2 intervals during the discharge of the middle portion of the batch (AASHTO R-60), the PTM method limits the amount of material placed before test results confirm the material meets specification.

As a reminder, protect the sample from sunlight, wind, and rapid evaporation during the period from sampling to the completion of testing with a damp burlap cloth. Re-mix the sample to ensure uniformity prior to testing. Start testing within 5 minutes of obtaining the sample and complete the tests within 15 minutes of obtaining the sample.

General Note: When obtaining samples for acceptance from the point of placement where the concrete is being passed thru a pump or conveyer, every effort should be made to ensure the material sampled is from the proper location.

IV.g. Concrete Test Cylinders – PTM 611 Method of Test for Making and Curing Concrete Compression and Flexural Test Specimens in the Field

The ASTM Designation is C31.

A copy of the most recent PTM 611 is included in this section. The differences between PTM 611 and the AASHTO/ASTM standards are numerous. PTM 611 should be thoroughly reviewed.

The following are some of the requirements specified in PTM 611.

PTM 611 specifies the use of only 6 x 12 inch cylinder molds for compression samples **molded in the field**. All concrete cylinders will be capped with tight fitting domed caps.

Specimens shall be molded on a level, rigid, horizontal surface free from vibration and other disturbances, at a place as near as practical to the place where they are to be stored during the first 24 hours. These specimens should not be moved after the initial 15 minutes up until the 24th \pm 2 hours. Proper consolidation of the concrete during molding of the test specimens is essential for accurate compressive strength test results. Improper or inadequate consolidation can cause low test results, perhaps by as much as 1,000 psi.

Do not scribe on the top surface of the cylinders. The flatness of the cylinder tops is also essential for obtaining optimum test results. Exact tolerances are specified in the PTM.

The initial cure of cylinders is critical in good strength development of the test samples. During the first 24 hour \pm 2 hours, all test specimens shall be stored under conditions that maintain the air temperature immediately adjacent to the specimens in the range of 60 to 80 °F and prevent loss of moisture from the specimens.

After 24 \pm 2 hours of curing under the above conditions, Acceptance specimens shall be removed from their molds and stored in a saturated lime solution (curing tank) at a constant temperature of 73 \pm 3 °F until tested for compressive strength at 28 days.

After initial cure, Quality Control cylinders are stripped from the molds at the time that the formwork is removed from the concrete placement, and they are cured and stored on the jobsite and receive the same protection from the elements, in so far as practical, as the structure which they are to represent.

PTM 611- Section 13 is for the identification and security of both the compression test specimen molds and compression test specimens. The signatures of the contractor's PENNDOT certified concrete field technician and the PENNDOT Representative are a security measure to ensure that the specimens are not tampered with prior to testing and/or at any time during the curing period. Note 12 provides guidance on how the compression test specimen sets are to be identified and numbered.

13. IDENTIFICATION AND SECURITY OF COMPRESSION TEST SPECIMEN MOLDS AND COMPRESSION TEST SPECIMENS MOLDED ON CONSTRUCTION PROJECTS

13.1 Identification of Specimen Molds- All compression test specimen molds shall be identified prior to molding of compression test specimens. A PENNDOT Representative shall identify each individual compression test specimen mold using a permanent marker. At a minimum, identification of the compression test specimen molds shall include the following information: date molded, construction area, specimen type, series number, and class of concrete (NOTE 12). In addition, the contractor's PENNDOT certified concrete field technician and the Representative of the Department shall affix their signatures to each compression test specimen mold. The contractor's PENNDOT certified concrete field technician will also legibly include their PENNDOT Concrete Field Technician certification number on each compression test specimen mold (NOTE 13).

NOTE 12- The construction area will be defined as Structure (S), Pavement (P), Pavement Patching (PP), Miscellaneous (M), or RPS Concrete Pavement (RPS). The specimen type will be defined as Acceptance Testing (AT), Quality Control (QC), Verification Testing (VT), Independent Assurance (IA), or Quality Assurance (QA). The series number of the first set of specimens molded in each construction area, molded on a specific project will be the number 1(one). Numbering of subsequent specimen series in each construction area will increase incrementally by 1(one) and will continue for the duration of the project

13.2 Identification of Specimens- Immediately after the compression test specimen molds are removed from the compression test specimens but prior to curing the compression test specimens, a PENNDOT Representative shall identify each individual compression test specimen using a permanent marker. The PENNDOT Representative will transfer the exact identifying information from the compression test specimen molds to the compression test specimens. In addition, the contractor's PENNDOT certified concrete field technician and the Representative of the Department shall affix their signatures to each specimen. The contractor's PENNDOT certified concrete field technician will also legibly include their PENNDOT Concrete Field Technician certification number (NOTE 13).

NOTE 13- The signatures of the contractor's PENNDOT certified concrete field technician and the PENNDOT Representative are a security measure to ensure that the specimens are not tampered with prior to testing and/or at any time during the curing period.

LABORATORY TESTING SECTION

Method of Test for

MAKING AND CURING CONCRETE COMPRESSION AND FLEXURAL TEST SPECIMENS IN THE FIELD

1. SCOPE

1.1 This method covers the procedures for making and curing specimens of concrete sampled from concrete being used in construction in accordance with AASHTO T 23 and T 231.

2. REFERENCED DOCUMENTS

2.1 AASHTO Standards

2.1.1 T 23, Making and Curing Concrete Test Specimens in the Field

2.1.2 T 119M/T 119, Slump of Hydraulic Cement Concrete

2.1.3 T 152, Air Content of Freshly Mixed Concrete by the Pressure Method

2.1.4 T 196M/T 196, Air Content of Freshly Mixed Concrete by the Volumetric
Method

2.1.5 T 231, Capping Cylindrical Concrete Specimens

2.1.6 T 309M/T 309, Temperature of Freshly Mixed Portland Cement Concrete

2.2 ASTM Standards

2.2.1 C287, Chemical-Resistant Sulfur Mortar

2.2.2 C470/C470M, Molds for Forming Concrete Test Cylinders Vertically

2.2.3 C1231/C1231M, Use of Unbonded Caps in Determination of Compressive
Strength of Hardened Cylindrical Concrete Specimens

2.3 Pennsylvania Test Methods (PTMs)

2.3.1 PTM No. 601, Sampling Fresh Concrete

2.3.2 PTM No. 631, Making and Curing Concrete Compression Specimens in
Precast and Prestressed Concrete Plants

3. APPARATUS

3.1 Molds for Compression Test Specimens- The molds shall be cylindrical, have non-absorbent surfaces and shall be substantial enough to hold their shape during the molding of test specimens (NOTE 1). All molds shall be provided with tight-fitting caps. The plane of the rim of the mold shall be normal to its axis. The molds shall not vary from the prescribed diameter (Section 7) by more than 1.6 mm (1/16 inch) nor from the prescribed length (Section 7) by more than 6.4 mm (1/4 inch). No two diameters shall differ more than 3.2 mm (1/8 inch) from each other. Reusable metal molds shall be provided with a machined metal base plate. Molds made of material other than metal shall be provided with a base plate or bottom, with a means for securing the base plate or bottom to the mold at a right angle to the axis of the cylinder. The mold shall stand upright on its base plate or bottom and the top end shall be open to receive the concrete. The assembled mold and base plate or bottom shall be oiled with a light coat of mineral oil before use. The assembly shall be watertight, and a suitable sealant used where necessary to prevent leakage through the joints. Paraffin cardboard molds, and sheet metal molds shall comply with the requirements of ASTM C470/C470M.

NOTE 1- Satisfactory molds may be made from cold-drawn, seamless steel tubing or from steel pipe. These tabular sections shall be cut to the proper length, split at one side parallel to the axis, and fitted with a circumferential metal band and bolt for closing. Split molds shall be machined inside to ensure a perfectly round shape after splitting and clamping. Satisfactory molds may also be made from iron or steel castings. Molds made from formed sheet metal must be used with care to ensure that they are not deformed more than the stipulated tolerances. Paraffin cardboard molds shall be used only under expert supervision. The use of a tube of heavy gage metal around sheet steel or cardboard molds, when the specimen is being molded, will preserve the dimensional integrity of the form. The use of plastic molds is also acceptable.

3.2 Molds for Flexure Test Specimens- Molds for flexure test specimens shall be rectangular and of the dimensions specified in Section 10. The mold shall be at least 50.8 mm (2 inches) longer than the length of the span. Molds shall be watertight and made of rigid, non-absorbent material. Means shall be provided for securing the base plate firmly to the mold. The inside surfaces of the mold shall be smooth and free from holes, indentations, or ridges. The sides, bottom, and ends shall be at right angles and shall be straight and true so that the specimen will not be warped. Maximum variation from the nominal cross-section shall not exceed 3.2 mm (1/8 inch). The assembled mold and base plate shall be lightly coated with mineral oil before use.

3.3 Tamping Rod- A round, smooth, straight, steel rod with a diameter conforming to the requirements in Table 1. The length of the tamping rod shall be at least 100 mm (4 inches) greater than the depth of the mold in which rodding is being performed, but not greater than 600 mm (24 inches) in overall length (see Note 2). The rod shall have the tamping end or both ends rounded to a hemispherical tip of the same diameter as the rod.

NOTE 2 - A rod of length of 400 mm (16 inches) to 600 mm (24 inches) meets the requirements of the following: T 119M/T 119, T 152, and T 196M/T 196.

Table 1 – Tamping Rod Requirements

Diameter of Cylinder or Width of Beam, mm (in.)	Rod Dimensions ^a	
	Diameter, mm (in.)	Length of Rod, mm (in.)
< 150 (6)	10 (3/8)	300 (12)
150 (6)	16 (5/8)	500 (20)

^a Rod tolerances length ± 100 mm (4 in.) and diameter ± 2 mm (1/16 in.).

3.4 Vibrators- Internal vibrators may have rigid shafts or flexible shafts, preferably powered by electric motors. The frequency of vibration shall be 7,000 rpm or greater. The outside diameter of the vibrating element shall be not smaller than 19 mm (3/4 inch) nor greater than 38 mm (1½ inches). The length of the shaft shall be at least 610 mm (24 inches). External vibrators may be of two types, either table or plank (NOTE 3). The frequency for external vibrators shall be 3,600 rpm or higher (preferably higher). For both table and plank vibrators a provision shall be made for clamping the mold securely to the apparatus. A tachometer shall be used to check the frequency of vibration.

NOTE 3- Vibratory impulses are frequently imparted to table or plank vibrators through electro-magnetic means, or by use of an eccentric weight on the shaft of an electric motor or on a separate shaft driven by a motor.

3.5 Small Tools- Tools and items such as shovels, pails, rubber mallets, trowels, wood floats, blunted trowels, straight-edges, feeler gages, scoops, and rulers shall be provided.

3.6 Slump Apparatus- The apparatus for measurement of slump shall conform to the requirements of AASHTO T 119M/T 119.

3.7 Sampling and Mixing Receptacle- A suitable pan, wheelbarrow, or a flat, clean non-absorbent mixing board of sufficient capacity to allow easy mixing by shovel or trowel of the entire sample.

3.8 Air Content Apparatus- The apparatus for measuring air content shall conform to the requirements of AASHTO T 196M/T 196 or AASHTO T 152.

3.9 Temperature Measuring Devices- The temperature measuring devices shall conform to the applicable requirements of T 309M/T 309.

4. SAMPLING CONCRETE

4.1 Samples of concrete for test specimens shall be taken in accordance with PTM No. 601. The place of depositing the load of concrete that was sampled shall be noted in the job records.

5. SLUMP AND AIR CONTENT

5.1 Slump- The slump of each load of concrete sampled for test specimens shall be measured, immediately after sampling, in accordance with AASHTO T 119M/T 119. Concrete used for the slump test shall be discarded.

5.2 Air Content- The air content of each load sampled for test specimens shall be determined in accordance with either AASHTO T 152 or AASHTO T 196M/T 196. Concrete used for determination of air content shall be discarded.

6. MOLDING SPECIMENS

6.1 Place of Molding- Specimens shall be molded on a level, rigid, horizontal surface free from vibration and other disturbances, at a place as near as practical to the place where they are to be stored during the first 24 hours. If it is not practical to mold the specimens where they will be stored, they may be moved to the place of storage within 15 minutes after being struck off (NOTE 4). All jarring, striking, tilting, or scarring of the surface of the specimens shall be avoided when moving specimens to a safe place.

NOTE 4- A trowel slipped under the bottom of a cardboard mold will aid in preventing distortion of the bottom during moving.

6.2 Method of Consolidation- Concrete at different slump levels require different methods of consolidation to prepare satisfactory test specimens. The selection of the method of consolidation shall be based on the slump, unless the method of consolidation of test specimens is stated in the specifications under which the work is being performed. The two methods of consolidation are rodding and internal or external vibration. Concrete with a slump greater than 76 mm (3 inches) shall be rodded. Concrete with a slump of less than 25 mm (1 inch) shall be consolidated by vibration. Concrete with a slump of 25 mm to 75 mm (1 inch to 3 inches) may be consolidated by either vibration or rodding (NOTE 5).

NOTE 5- Concrete with a zero slump and relatively dry mixtures used in pipe and block plants may require the use of special means for consolidation. This concrete is not covered by this method.

6.3 Placing the Concrete- The concrete shall be placed in the molds in two or three layers using a scoop or blunted trowel. In placing each portion of concrete, the scoop or trowel shall be moved around the top edge of the mold as the concrete is discharged in order to ensure a symmetrical distribution of the concrete and minimize segregation of the coarse aggregate within the mold. The concrete may be further distributed by use of a tamping rod prior to the start of

consolidation. After consolidation by any of the methods described above, the surface of the concrete shall be struck off without undue manipulation using a straightedge or trowel, the beams are finished with a wood float, and all specimens are covered immediately with glass or metal plates, polyethylene film, or other covering to prevent evaporation.

6.4 Relation between Specimen Size and Aggregate Size- The diameter of the cylindrical specimen or the minimum cross-section dimension of a concrete beam shall be at least three times the maximum nominal size of the coarse aggregate in the concrete. Occasional oversize aggregate particles may be removed by hand picking during the molding of the specimens.

COMPRESSION TEST SPECIMENS

7. SPECIMENS

7.1 Size of Specimens- Compression test specimens shall be cylindrical, with a length equal to twice the diameter. The standard specimen shall be a 152 mm x 305 mm (6-inch by 12-inch) cylinder when the nominal maximum size of the aggregate does not exceed 50 mm (2 inches). When the nominal maximum size of the coarse aggregate does not exceed 25 mm (1 inch), the specimen may be a 102 mm x 203 mm (4-inch by 8-inch) cylinder, for mix design purposes only. Cylinders 102 mm x 203 mm (4-inch by 8-inch) are permitted in pre-cast plants as stated in PTM No. 631. Specimens smaller than 152 mm (6 inches) diameter shall not be made from concrete sampled in the field.

7.2 Molding Specimens- Specimens shall be molded as prescribed in Section 6. An inverted slump cone or suitable funnel may be used to direct concrete into the mold.

7.3 Identification of Specimens- Compression Test Specimens shall be identified as prescribed in Section 13.

8. METHOD OF CONSOLIDATION

8.1 Rodding- The concrete shall be placed in the mold in three layers of approximately equal volume. Using the tamping rod with the hemispherical tip in contact with the concrete, each of the layers shall be rodded 25 strokes. The bottom layer shall be rodded throughout its depth. The strokes shall be distributed uniformly over the cross-section of the mold, and for each layer the strokes shall penetrate about 25 mm (1 inch) into the underlying layer. If voids are left by the tamping rod, the sides of the mold shall be tapped lightly to close the voids.

8.2 Vibration- A standard duration of vibration shall be observed for the particular kind of concrete, vibrator, and specimen mold involved. Vibration shall be continued only long enough to achieve proper consolidation of the concrete. Over vibration may cause segregation. The mold shall be filled and vibrated in two approximately equal layers. All of the concrete for each layer shall be placed in the mold before starting vibration of that layer. The second layer shall be added so as to avoid overfilling by more than 6.4 mm (1/4 inch). After vibrating the second layer, enough concrete shall be added and worked into the surface concrete with a trowel to overfill the mold

about 3.2 mm (1/8 inch) and then struck off. The duration of vibration required will depend upon the workability of the concrete and the effectiveness of the vibrator. Usually, sufficient vibration has been applied as soon as the surface of the concrete becomes relatively smooth in appearance.

8.2.1 Internal Vibration- Three insertions of the vibrator at different points shall be used for each layer. In compacting the bottom layer, the vibrator shall not be allowed to rest on the bottom or touch the sides of the mold. The vibrator shall penetrate through the second layer and into the bottom layer by approximately 25 mm (1 inch). Care shall be taken that the vibrator is withdrawn in such a manner that no air pockets are left in the specimen.

8.2.2 External Vibration- When external vibration is used, care shall be taken to ensure that the mold is rigidly attached to or securely held against the vibrating element or surface.

9. CAPPING SPECIMENS

9.1 General Provisions- The ends of all compression test specimens that are plane within 0.05 mm (0.002 inch) shall be capped or ground plane. Capped surfaces shall not depart from a plane by more than 0.05 mm (0.002 inch). The plane of the caps of every tenth specimen shall be checked by means of a straightedge and feeler gage, making a minimum of three measurements on different diameters. The capped surface of the specimen in contact with the lower bearing block of the testing machine shall not depart from perpendicularity to the axis of the cylinder by more than 0.5 degree (approximately equivalent to 3 mm in 305 mm (1/8 inch in 12 inches) and the combined departure of the two capped surfaces from perpendicularity to the axis shall not exceed 3 degrees. Caps shall be made as thin as practical. Any capping material when tested as 50.8 mm (2-inch) cubes of the same age and composition as the caps of the concrete cylinder shall develop a compressive strength greater than the anticipated strength of the concrete cylinder (NOTE 6). Caps made from mixtures of sulfur type materials shall be formed against metal plates. Metal plates shall be at least 25 mm (1 inch) greater in diameter than the specimen, and shall not depart from a plane by more than 0.05 mm (0.002 inch). In no case shall the recess formed by the plates(s) be greater than 13 mm (1/2 inch). Adhesion of the capping material to the capping plate may be avoided by coating the plate with light machine oil or mineral oil. Suitable alignment devices shall be used in conjunction with the plates to ensure that the specified perpendicularity of the caps and the axis of the specimen is attained. Surface roughness of newly finished metal plates shall not exceed 3.2 micrometers (125 micro-in.) as set forth in Table 4 of ASA B46.1 on Physical Specimens of Surface Roughness and Lay for any type of surface and direction of lay. The surface when new shall be free from gouges, grooves, or indentations beyond those caused by the finishing operations.

NOTE 6- The compressive strength of mixtures of sulfur and granular materials may be determined in accordance with Section 7 of ASTM C287.

9.2 Sulfur and Granular Materials- Proprietary or laboratory prepared mixtures of sulfur and granular materials may be used and caps shall be allowed to harden at least 1/2 hour before the specimens are tested. A melting pot equipped with automatic temperature controls shall be used for heating these mixtures.

NOTE 7- Caution. Melting pots equipped with peripheral heating will protect against accidents happening when reheating cooled sulfur mixtures that have a crusted-over surface. When using melting pots that are not so equipped, care should be exercised to avoid the build-up of pressure under the hardened surface crust by means of a metal rod which contacts the bottom of the pot and projects above the surface of the fluid sulfur mix as it cools. The rod shall be of sufficient size to conduct enough heat to the top, on reheating, to melt a ring around the rod first and thus avoid the development of pressure. Sulfur melting pots shall be used under a hood to exhaust the fumes to the outdoors. The proper range of pouring temperature is from 129 °C to 143 °C (265F to 290F). Since the flash point of sulfur is approximately 227 °C (440F), the mixture may ignite due to overheating. Heating over an open flame is dangerous. Should the mixture start to burn, covering it will snuff out the flame. If the flame is extinguished immediately, the sulfur mixture may be used for capping.

9.3 Neoprene Caps- Use of neoprene caps shall be considered as a suitable alternate for use in compressive strength testing. The material and procedure shall be in accordance with ASTM C1231/C1231M. When 102 mm x 203 mm (4-inch by 8-inch) cylinders are used, neoprene caps are required 105 mm (4 1/8 inches) in diameter and 12.7 mm (1/2 inch) thick. The material and procedure shall be in accordance with the Annex listed in PTM No. 631.

FLEXURE TEST SPECIMENS

10. SIZE OF SPECIMENS

10.1 The size of flexure test specimens shall be rectangular beams 152 mm x 203 mm x 559 mm (6 inches by 8 inches by 22 inches). Maximum variation from the nominal cross-section shall not exceed 3.2 mm (1/8 inch).

11. PLACING AND CONSOLIDATION

11.1 Placing Concrete- The concrete shall be placed in the molds using a scoop or shovel. Molds 203 mm (8 inches) or less in depth shall be filled in two approximately equal layers. An effort shall be made to minimize segregation while filling the molds. Concrete shall be symmetrically distributed within the mold. The concrete may be distributed by means of the tamping rod prior to the start of consolidation.

11.2 Rodding- Each layer shall be rodded evenly over its area 50 times. The bottom layer shall be rodded throughout its depth. The upper layers shall be rodded so that the strokes penetrate approximately 12 mm (1/2 inch) into the immediately underlying layer. The top layer shall slightly overfill the mold. After each layer is rodded, the concrete shall be spaded along the sides and ends of the mold with a trowel or other suitable tool. The sides of the mold shall be tapped with a rubber mallet to close the voids.

11.3 Vibration- Vibration shall be continued only long enough to achieve proper consolidation of the concrete. Over vibration may cause segregation. The duration of vibration required will depend upon the workability of the concrete and the effectiveness of the vibrator. Usually, sufficient vibration has been applied when the surface of the concrete becomes relatively smooth in appearance.

11.3.1 Internal Vibration- The vibrator shall be inserted at intervals not exceeding 150 mm (6 inches) along the center line of the long dimension of the specimen. For specimens wider than 150 mm (6 inches), alternating insertions along two lanes shall be used. The vibrator shall not be allowed to rest on the bottom or strike the sides of the mold. The vibrator shall penetrate into the bottom layer approximately 25 mm (1 inch). Care shall be taken that the vibrator is withdrawn in such a manner that no air pockets are left in the specimen.

11.3.2 External Vibration- When external vibration is used, care shall be taken to ensure that the mold is rigidly attached to or securely held against the vibrating element or vibrating surface.

CURING COMPRESSION AND FLEXURAL TEST SPECIMENS

12. SPECIMENS

12.1 Specimens for Checking the Strength of Concrete for Trial Mix Designs- Molds shall be placed on a rigid horizontal surface free from vibration and other disturbances. During the first 24 hours \pm 2 hours, all test specimens shall be stored under conditions that maintain the air temperature immediately adjacent to the specimens in the range of 16 °C to 27 °C (60F to 80F) and prevent loss of moisture from the specimens. Storage temperatures may be regulated by means of ventilation or by evaporation of water from sand or burlap (NOTE 8), or by using heating devices such as stoves, electric light bulbs, or thermostatically controlled heating cables. A temperature record of the specimens shall be maintained by means of high-low thermometers or other appropriate temperature recording devices. Specimens may be stored in tightly constructed, firmly-braced wooden boxes, damp sand pits, or temporary buildings at construction sites, under wet burlap in favorable weather, or by other suitable methods, provided the foregoing requirements limiting specimen temperature and moisture loss are met. Specimens formed in cardboard molds shall not be stored for the first 24 hours \pm 2 hours in contact with wet sand or wet burlap or under any other conditions that will allow the mold to absorb water. Cardboard molds can be covered with a layer of polyethylene sheeting and wet burlap can be placed over the molds. After 24 hours \pm 2 hours of curing under the above conditions, the specimens shall be removed from the molds and stored in a saturated lime solution (curing tank). Specimens shall be protected from dripping or running water. At the end of the curing period, between the times the specimen is removed from curing until testing is completed, drying of the surfaces of the specimens shall be prevented (NOTE 10). Specimens shipped from the field to the laboratory for testing shall be packed in a sturdy wooden box or other suitable container surrounded by wet sawdust or wet sand and protected from freezing during shipment (NOTE 11). Upon receipt by the laboratory, the specimens shall be placed immediately in moist curing at 23 °C \pm 2 °C (73F \pm 3F). In all cases, the demolded

specimens shall be kept in a moist condition (NOTE 9) in the temperature range of $23\text{ }^{\circ}\text{C} \pm 2\text{ }^{\circ}\text{C}$ ($73\text{F} \pm 3\text{F}$).

NOTE 8- The temperature within damp sand and under wet burlap or similar materials will always be lower than the temperature in the surrounding atmosphere if evaporation takes place.

NOTE 9- A moist condition is that in which free water is maintained on the surface of the specimens at all times.

NOTE 10- Relatively small amounts of drying of the surface of flexural specimens induce tensile stresses in the extreme fibers that will markedly reduce the indicated flexural strength.

NOTE 11- Under no conditions shall the specimens be disturbed or moved between 15 minutes and 24 hours ± 2 hours after molding. Any disturbances of the specimen may cause a reduction in final test results.

12.2 Specimens for Field Control- Specimens shall be placed on a rigid horizontal surface free from vibration and other disturbances. During the first 24 hours ± 2 hours, all test specimens shall be stored under conditions that maintain the air temperature immediately adjacent to the specimens in the range of $16\text{ }^{\circ}\text{C}$ to $27\text{ }^{\circ}\text{C}$ (60F to 80F) and prevent loss of moisture from the specimens. Storage temperatures may be regulated by means of ventilation or by evaporation of the water from sand or burlap (NOTE 8), or by using heating devices such as stoves, electric light bulbs, or thermostatically controlled heating cables. A temperature record of the specimens shall be maintained by means of high-low thermometers or other appropriate temperature recording devices. Specimens may be stored in tightly constructed, firmly-braced wooden boxes, damp sand pits, temporary buildings at construction sites, under wet burlap in favorable weather, or by other suitable methods, provided the foregoing requirements limiting specimen temperature and moisture loss are met. Specimens formed in cardboard molds shall not be stored for the first 24 hours ± 2 hours in contact with wet sand or wet burlap or under any other conditions that will allow the mold to absorb water. Cardboard molds can be covered with a layer of polyethylene sheeting with wet burlap placed over them. After 24 hours ± 2 hours of curing under the above conditions, the specimens shall be stored in or on the structure as near to the point of use as possible, and shall receive, insofar as practical, the same protection from the elements on all surfaces as is given to the portions of the structure which they represent. Specimens shall be tested in the moisture condition resulting from the specified curing treatment (NOTE 10). To meet these conditions, the specimens shall be removed from the molds at the time of removing form work (NOTE 11).

13. IDENTIFICATION AND SECURITY OF COMPRESSION TEST SPECIMEN MOLDS AND COMPRESSION TEST SPECIMENS MOLDED ON CONSTRUCTION PROJECTS

13.1 Identification of Specimen Molds- All compression test specimen molds shall be identified prior to molding of compression test specimens. A PennDOT Representative shall

identify each individual compression test specimen mold using a permanent marker. At a minimum, identification of the compression test specimen molds shall include the following information: date molded, construction area, specimen type, series number, and class of concrete (NOTE 12). In addition, the contractor's PennDOT certified concrete field technician and the Representative of the Department shall affix their signatures to each compression test specimen mold. The contractor's PennDOT certified concrete field technician will also legibly include their PennDOT Concrete Field Technician certification number on each compression test specimen mold (NOTE 13).

NOTE 12- The construction area will be defined as Structure (S), Pavement (P), Pavement Patching (PP), Miscellaneous (M), or RPS Concrete Pavement (RPS). The specimen type will be defined as Acceptance Testing (AT), Quality Control (QC), Verification Testing (VT), Independent Assurance (IA), or Quality Assurance (QA). The series number of the first set of specimens molded in each construction area, molded on a specific project will be the number 1(one). Numbering of subsequent specimen series in each construction area will increase incrementally by 1(one) and will continue for the duration of the project.

13.2 Identification of Specimens- Immediately after the compression test specimen molds are removed from the compression test specimens but prior to curing the compression test specimens, a PennDOT Representative shall identify each individual compression test specimen using a permanent marker. The PennDOT Representative will transfer the exact identifying information from the compression test specimen molds to the compression test specimens. In addition, the contractor's PennDOT certified concrete field technician and the Representative of the Department shall affix their signatures to each specimen. The contractor's PennDOT certified concrete field technician will also legibly include their PennDOT Concrete Field Technician certification number (NOTE 13).

NOTE 13- The signatures of the contractor's PennDOT certified concrete field technician and the PennDOT Representative are a security measure to ensure that the specimens are not tampered with prior to testing and/or at any time during the curing period.

IV.h. Testing Facilities and Equipment – Section 704.1(d)3

By specification, it is the contractor's responsibility to provide all testing facilities and equipment used in the acceptance testing process. Equipment must be provided for each separate project operation as needed.

Minimum testing equipment available for field use:

1. 2 Slump cones and rods as per AASHTO T 119
2. 2 Air meters, calibrated*, as per AASHTO T 196 or AASHTO T 152
3. Calibrated thermometer with range of 30 °F to 120 °F per ASTM C1064.
4. Small tools – rubber mallet, wood float, hand trowels, ruler, 5-gallon bucket, long handled square shovel, metal straight edge, scoop.
5. Safety equipment – rubber gloves, safety glasses, hard hat and first-aid kit.
6. Wheelbarrow and wet burlap for concrete samples
7. Sufficient supply of cylinder molds and caps
8. Curing boxes, or other acceptable equipment, for compressive strength specimens as required in PTM 611 Sections 12.1 and 12.2 and a sufficient number of high-low thermometers to monitor temperature next to the cylinders.
9. Compression machine** on the project or at an approved location.
10. One or more maturity meters and a sufficient number of temperature sensors meeting the requirements in PTM No. 640 if using the maturity method to estimate concrete compressive strength.

* Calibrate air meters in the presence of the inspector a maximum of 2 weeks before beginning concrete placements and every 2 weeks during concrete placements.

** Calibrate compression machine at least once per year and whenever the machine is relocated or moved.

IV.i. Care of Concrete Test Cylinders

The majority of cylinders molded on a project are Acceptance cylinders (AT) and Quality Control (QC) cylinders. After the first 24 hours, Acceptance cylinders are cured in accordance with PTM 611 Section 12.1 and QC cylinders are cured in accordance with PTM 611 Section 12.2.

Regardless of the method of cure, the cylinders must be stored for initial curing within 15 minutes of being struck-off. Specifications call for the same protection for all cylinders after the first fifteen minutes to 24 hours (± 2 hours). The cylinders must be cured at a constant moist, temperature between 60 °F and 80 °F. The curing condition of the cylinders for the first 24 hours has the greatest effect on the strength gain properties of the cylinder. While PTM 611 refers to several methods of cure, the typical scenario involves plastic cylinder molds with tight fitting domed plastic caps and a wooden cure box at the testing location on the jobsite. The curing box should be durable, insulated and large enough to allow adequate ventilation around the cylinders. As noted above, after the first 15 minutes to 24 hours (± 2 hrs), the cylinders need to be kept at a constant temperature from 60 °F to 80 °F in a moist condition free from vibration or disturbance. Temperature needs to be monitored with a Hi/Low thermometer. The temperature range of 60 °F to 80 °F, or the ideal target of 73 °F, can be maintained with alternating use of water, ice or insulated blankets.

The importance of maintaining the concrete temperature within the specific range can best be illustrated by the graph on the next page. Note that the effects of twenty-four hour versus twenty-eight-day strength are least affected when held to 60 °F to 80 °F. However, as noted in the graph, high-early temperature will greatly reduce the twenty-eight-day strengths. Note the decrease in compressive strength at 28 days as the initial curing temperatures increase. The most dramatic loss at 28 days will result from cylinders above 80 °F for the first 24 hours. For this example, a cylinder cured at 75 °F at 24 hours will result in 28-day strength of 5800 psi while an identical cylinder cured at 105 °F at 24 hours will have 28-day strength of 4900 psi.

As noted above, Acceptance cylinders are cured in accordance with PTM 611 Section 12.1. After the first 24 ± 2 hours the cylinder molds are removed, and the cylinders are kept moist in a lime bath curing tank at a constant temperature of 73 ± 3 °F until they are tested for compressive strength at 28 days.

Also as noted above, QC cylinders are cured in accordance with PTM 611 Section 12.2. After the first 24 ± 2 hours the cylinders are stored in or on the structure they represent and shall receive, in so far as practical, the same protection from the elements on all surfaces as is given to the structure they represent. QC cylinders are removed from the molds at the time of removing formwork and are to be cured in the same manner as the structure they represent until they are tested for 28-day compressive strength or the specified intermediate time period.

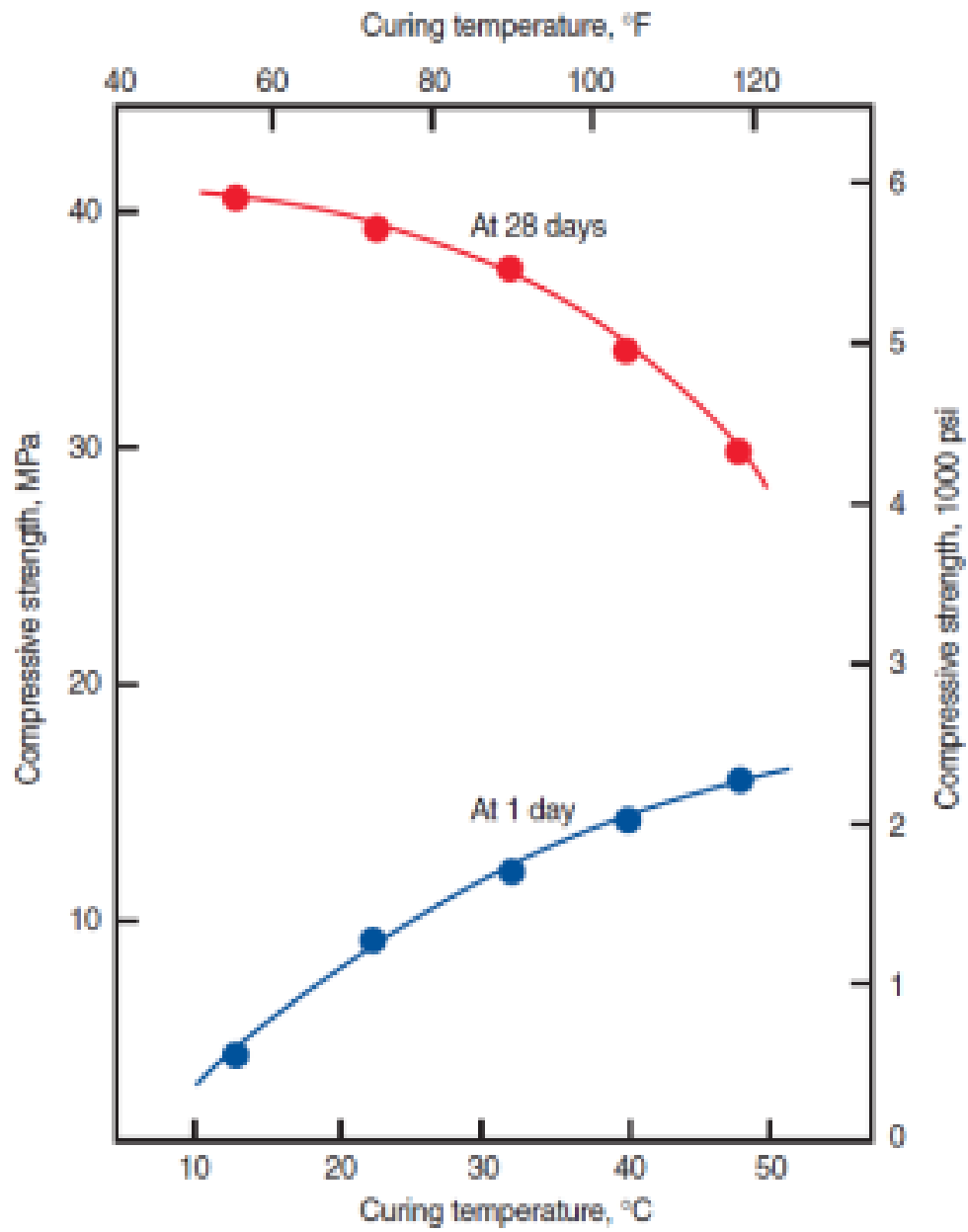

IV.j. Compressive Strength of Molded Cylinders – PTM 604 Method of Test for Compressive Strength of Molded Concrete Cylinders

PTM 604 is the Pennsylvania Test Method for Compressive Strength of Molded Concrete Cylinders. AASHTO T-22 has been modified by this PTM with respect to Sections 1.5 and 7.1.1 and 7.3.1. The ASTM Designation is C-39.

ASTM C-39 – Test Method for Compressive Strength of Cylindrical Concrete Specimens is not addressed in the ACI Concrete Field Testing Technician – Grade I Course.

PTM 604 covers the procedures for compression testing of molded concrete cylinders. The specification does not cover calibration of the compression machine, but typically this is covered by the quality control plan submitted by the ready mix producer. By specification, compressive strength machines must be calibrated annually or whenever they are moved or relocated.

If neoprene caps are used in lieu of sulfur or granular compounds, refer to PTM 604 for proper procedures. Neoprene caps are more widely used because they are re-usable. Under no circumstances should the use of neoprene pads exceed 100 cylinder tests per pad. This must be verified prior to testing the cylinders. Neoprene pads should be replaced prior to 100 cylinder tests if the pads are observed to have excessive wear or are cracked.

Results of compressive strength tests should be reported on PennDOT Form CS-458A. A sample form is included in this manual along with all the appropriate information that should be included on the form.

Note: There is a construction training video created on Compressive Strength Testing of molded concrete cylinders. It can be located on PPCC or YouTube.

PPCC - You will need to use your ECMS credentials to log into PPCC. Once in PPCC, click on the References tab of the PPCC Portal, click on the Central Office folder, click on the Construction Training Videos folder, and you will find the video named "*Compressive Strength Testing on Concrete Specimens*".

YouTube - For anyone without PPCC access the video has been posted on YouTube as “unlisted”, which means a person will need to use the link below to access the training video.

https://youtu.be/_eI6TfHAUiw

Access to all Construction Training Videos can be found at:

<https://www.youtube.com/playlist?list=PL90uZRd80y1PO8xSMVfHyITyMa2DGBIHg>

IV.k. Obtaining and Testing Drilled Cores of Concrete - PTM 606 Method of Test for Obtaining and Testing Drilled Cores of Concrete

Section 110.10 was revised in the 2016 edition to reference PTM 606 and no longer require conditioning of core samples as previously required by Strike-Off-Letter 481-15-02.

Section 110.10(d) Evaluation, Disposition, and Payment of Low Strength Cement Concrete Using Concrete Core Specimens. *Core locations will be randomly selected within the deficient lot of concrete according to PTM No. 1. Obtain cores, under the direction and supervision of the Representative, within 1 week of notification, at no additional cost to the Department.*

Obtain five cores from the deficient lot of concrete.

Obtain cores according to PTM No. 606, except as follows:

Obtain 4-inch diameter cores, which are free of reinforcing steel. A pachometer will be used to locate the reinforcing steel. If 4-inch diameter cores free of reinforcing steel cannot be obtained, smaller diameter cores may be allowed provided the core diameter is at least three times the nominal maximum size of the coarse aggregate used in the concrete mix, but not less than 2 inches.

Deliver cores immediately to the Representative. Cores will be delivered to the LTS within 3 working days. Cores will be prepared for testing according to PTM No. 606 and compressive strength testing will be conducted according to PTM No. 604.

PTM 606 is the method that covers the procedures for obtaining, preparing, and testing cores drilled from concrete for length or for compressive strength determinations. **This method replaces previously referenced AASHTO T 24 regarding obtaining and drilling cores of concrete.**

IV.l. Concrete Air Meter Calibrations – 408/704.1(d)3 Testing Facilities and Equipment

As noted earlier, it is the contractor's responsibility to ensure there is a sufficient amount of testing equipment available on a project to ensure all testing, AT & QC can be performed throughout the project. This includes providing a sufficient amount of back-up equipment in the event of a breakdown. Also, *"In the presence of the Inspector, calibrate all air meters a maximum 2 weeks before beginning concrete placement. Re-calibrate all air meters, in the presence of the Inspector, every 2 weeks during concrete placement."* The Inspector will document these calibrations in the Concrete Inspectors Diary.

The calibration procedures vary from manufacturer to manufacturer. AASHTO T-152 and AASHTO T-196 outline general calibration procedures for both pressure meters and volumetric air meters. The manufacturer's instructions for each individual meter provide more detailed instruction specific to that make of meter and should be followed.

The manufacturer's instruction should be maintained with each meter for easy access when calibrating the air meters.

An example of the calibration and operating instructions for a FORNEY brand PRESS-AIRE METER is provided on the following page.

PRESS-AIRE™ METER

Model LA-0316

FORNEY

OPERATING INSTRUCTIONS

1. Fill base with concrete according to ASTM C-231 and strike off. Clean cover and base rim; clamp together.
2. Open petcocks. Use syringe to inject water through one petcock until water is expelled from opposite petcock.
3. Close air bleeder valve on air chamber. Pump up air initial pressure line gauge. Wait a few seconds, tap gauge lightly. If necessary, add or release air to attain reading at initial pressure line. Close petcocks.
4. Press needle valve lever to release air into base. Continue pressing lever and lightly tap gauge. Read direct percentage of air.
5. Thoroughly clean base, cover and petcock openings with running water.

CALIBRATION INSTRUCTIONS

1. Screw short piece of tubing tightly into petcock hole on underside of cover (note which petcock). Fill base with water. Clamp cover to base.
2. Using syringe, inject water into petcock having short tubing until water is expelled through opposite petcock.
3. Pump until gauge reads slightly beyond pre-established initial pressure line (generally 3%). Wait a few seconds. If necessary, pump or bleed-off air to adjust hand to initial pressure line.
4. Close petcocks. Press needle valve lever to release air in to base. Wait a few seconds until gauge hand stabilizes. Gauge should read 0% if initial pressure line was correct. If two or more tests produce consistent variations from 1%, change initial pressure line compensate for variation. Use new initial pressure line for subsequent tests.
5. Screw curved tube into petcock having short tubing. Open petcock. Press needle valve lever and fill calibrating vessel.
6. Open opposite petcock allowing water in curved pipe to run back into base. Base now contains 5% air.
7. Pump up air pressure to initial pressure line (3%). Close petcocks. Press needle valve lever. Wait a few seconds for needle to stabilize. Press lever again to release any remaining air. Gauge should now read 5%.
8. If two or more tests show gauge reads incorrectly at 5% air in excess of 0.2%, then reset gauge hand by turning recalibrating screw on gauge hand (on older meters, screw is on dial face).
9. When gauge hand reads correctly at 5%, additional water may be withdrawn in the same manner to check results 10%, 15%, 20%, etc.

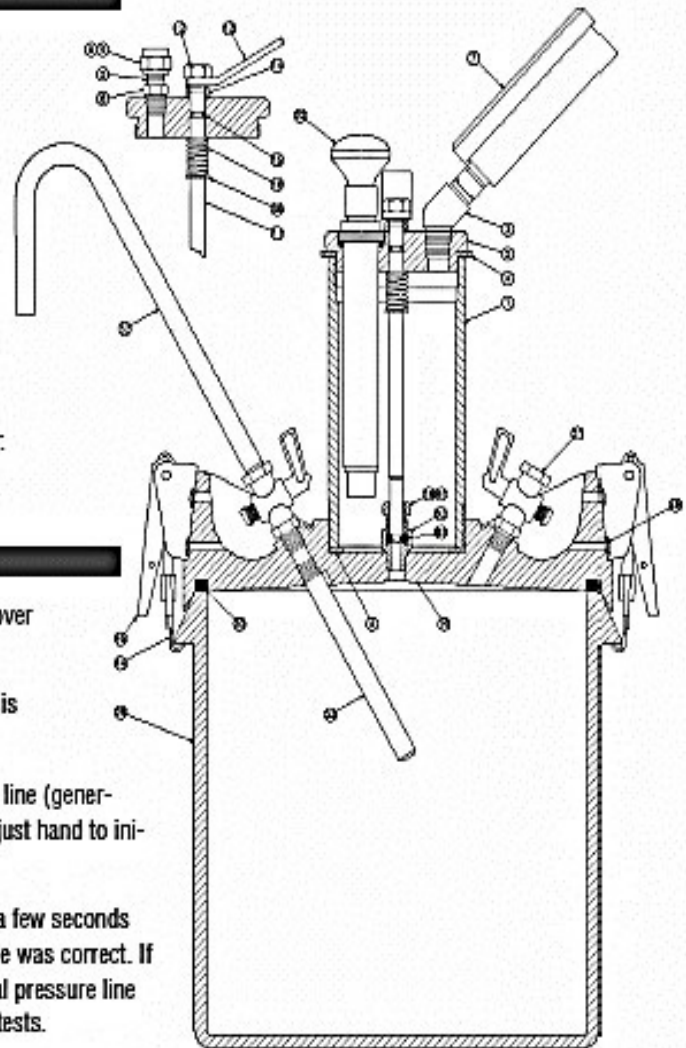

QTY	NO.	PART NO.	DESCRIPTION
1	1	LA-0316-01	PRESSURE CHAMBER
1	1	LA-0316-02	CHAMBER CAP
1	1	LA-0316-03	CHAMBER PIN
2	2	LA-0316-04	CHAMBER GASKET
1	1	LA-0316-05	AIR BLEEDER VALVE ASSEMBLY
1	1	LA-0316-06	AIR BLEEDER VALVE CAP
1	1	LA-0316-07	GAGE CONDUIT
1	1	LA-0316-08	AIR BLEEDER VALVE STEM
1	1	LA-0316-09	AIR BLEEDER VALVE GASKET
1	1	LA-0316-11	NEEDLE VALVE STEM
1	1	LA-0316-12	NEEDLE VALVE NUT
1	1	LA-0316-13	NEEDLE VALVE LEVER
1	1	LA-0316-14	NEEDLE VALVE SPRING
1	1	LA-0316-15	NEEDLE VALVE O-RING
1	1	LA-0316-16	NEEDLE VALVE SPRING
1	1	LA-0316-18	NEEDLE VALVE SEAL
1	1	LA-0316-19	LID
1	1	76-0030	O-RING LID SEAL
2	2	LA-0316-21	1/8" PETCOCK
1	1	LA-0316-22	1/8" PETCOCK
1	1	LA-0316-23	1/8" PETCOCK
1	1	LA-0316-24	BASE, 20 CURC FTIT
1	1	LA-0316-26	NEEDLE VALVE STEM SNAP RING
1	1	LA-0316-44	LATCH TAB
4	4	LA-0316-45	LATCH ASSEMBLY
12	12	LA-0316-46	PLATE W/40 HOLES #10 X 1/2"
1	1	LA-0316-61	3/16" 4188 NUT
1	1	LA-0316-62	3/16" X 1/2" MALE CONNECTOR
1	1	LA-0316-63	O-RING #2-201

Replacement parts available.
Contact Forney Sales at 724 346 7400

IV.m. Packaging QA Cylinders being sent to LTS - PUB 408 Section 704.1(d)7 QA Testing

Section 704.1(d)7 covers the QA testing being performed in the field during a review. This Section also covers how to package the QA cylinders being sent to the LTS for 28-Day compressive strength testing and hardened air content testing. *"Furnish packaging material and package cylinders under the direction and supervision of the Representative. Place the cylinders in individual containers cushioned with suitable material to prevent damage during shipment. The total weight of each container, cylinder and cushioning material must not exceed 50 pounds."*

Properly packaging the QA cylinders is a very important part in keeping the cylinders protected during transportation to the LTS. This provides the best chance of the cylinders comparing to the field cylinders at the project. See below for some Good and Bad examples of cylinder packaging.



Bad Examples: These cylinders do not have any protection from damage during shipping and the cylinder in the 6" PVC pipe was difficult to remove.



Good Examples: Cylinders packaged in a fashion to prevent the cylinders from damage during shipping. Wooden boxes with Styrofoam or sand can be used provided they do not exceed 50 pounds.

Review Questions

IV. PADOT Concrete Testing Procedures

1. All Pennsylvania Test Methods (PTM's) have been eliminated by the Department and replaced with AASHTO Standards. True / False .
2. When testing for plastic air content, the aggregate correction factor must be calculated for each concrete mix and added to the results obtained using AASHTO T- 152 or T-196 methods. True / False
3. PTM 601, Sampling Fresh Concrete, specifies that concrete must be sampled from what portion of the load? _____
4. The Department specifies in Section 704.1(d)4.a that concrete temperatures are to be taken in accordance with ASTM_____ "Standard Test Method for Temperature of Freshly Mixed Hydraulic-Cement Concrete".
5. After the initial 15 minutes, PTM 611 specifies the initial cure period for all cylinders is _____ hours + _____ hours.
6. The contractor must re-calibrate air meters, including back-up air meters, _____ during concrete placements.
7. All concrete test cylinders must be covered during initial curing using _____.
8. Cylinders need only to be identified with the date molded and the series number. True / False
9. Plastic air content for concrete with lightweight aggregates must be obtained by testing using the _____ method.
10. Neoprene caps may be re-used for compression testing of cylinders a maximum of _____ times.
11. Compressive strength testing machines must be calibrated _____ or _____.
12. After initial cure, Quality Control cylinders are stripped from the molds at the time that the form work is removed from the concrete placement, and they are cured and stored on the jobsite and receive the same protection from the elements, in so far as practical, as the structure which they are to represent. True / False
13. Refer to the _____ instructions for complete detailed procedures when calibrating air meters.

Review Questions – cont'd

IV. PADOT Concrete Testing Procedures

14. All concrete testing should be completed within _____ minutes of obtaining the sample.
15. Concrete samples do not need to be protected from the elements with damp burlap if all testing is completed within 15 minutes of obtaining the sample. True / False
16. A pressure meter is used to test plastic air content of concrete using lightweight aggregates. True / False
17. The bowl of a pressure meter may be used to as the measuring vessel for determining the unit weight of a concrete sample. True / False
18. The slump and air content shall be determined before 1/3 of the batch has been placed. True / False
19. After the first 15 minutes up until 24 hours (± 2 hrs), cylinders must be cured at a constant, moist temperature between _____ $^{\circ}\text{F}$ and _____ $^{\circ}\text{F}$.
20. After the first 24 hours (± 2 hrs), acceptance cylinders are cured in a lime bath solution at a constant temperature between _____ $^{\circ}\text{F}$ and _____ $^{\circ}\text{F}$ until compressive strength testing is performed at _____ days.

Review Question Answers

I. Quality Control Practices

1. 20 (pg. 12)
2. 50° F - 80° F (pg. 13)
3. 8 inches (pg. 16)
4. 50° F - 100° F (pg. 13)
5. ± 1.5 inches (pg. 17)
6. True (pg. 6)
7. 45 minutes (pg. 13)
8. contractor's technician (pg. 20)
9. False – only for slump (workability) when permitted by the District (pg. 21)
10. False – may be allowed to mix on agitating revolutions for a period of time or sit with barrel stopped not to exceed 45 minutes (pg. 21)
11. 1 gal/cy (pg. 19)
12. False – contractor may elect to use the concrete provided a complete set of AT & QC cylinders are molded & tested for acceptance (pg. 20)
13. 300 (pg. 13)
14. True - contractor may elect to use the concrete provided a complete set of AT & QC cylinders are molded & tested for acceptance (pg. 20)
15. Quality Control Plan (pg. 6)
16. 0.06 (pg. 13)
17. none – PENNDOT does not permit the addition of water to raise the air content (pg. 21)
18. True (pg. 14)
19. three (pg. 15)
20. 50 (pg. 15)

Review Question Answers

II. Project Documentation

1. True (pg. 28)
2. True (page 40)
3. quality control plan, approved mix design, batcher-mixer slip, delivery ticket (pg. 24)
4. True (pg.24)
5. True (pg 26)
6. CS-458A (pg. 37)
7. fly ash, silica fume, slag cement – all are pozzolans (pg 40)
8. True (pg 31)
9. 8.33 lbs. (pg 52)
10. 0.43 (pg 40)
11. one (1) (pg 52)
12. 0.45 (pg 40)
13. 10 psi (pg. 37)
14. $0.41 \frac{[2048 + (65 \times 10)]}{6580}$ (pg. 41)
15. 1 gal/cy (pg. 52).
16. Surface Moisture in Aggregates + Wash down water + Ice (pg. 40)
17. True (pg. 24)
18. 0.7 gal/cy. 1 gal/cy would exceed the max water permitted by the mix design
19. 142 lbs $((17,848 \text{ lbs} / 1.008 = 17706 \text{ lbs})(17,848 \text{ lbs} - 17706 \text{ lbs} = 142 \text{ lbs}))$ (pg. 48-49)
20. 0.44 (pg. 48-49)

Review Question Answers

III. Acceptance Process

1. True (pg. 55)
2. True (pg. 55)
3. True (pg. 57)
4. True (pg. 55)
5. False – 28-day QC compressive strength results are also required to confirm strength gain of in place concrete (pg. 55)
6. 28-day compressive strength is obtained or 28 days (pg. 59)
7. contractor (pg. 59)
8. False – 28-day compressive strength testing for AT & QC is required (pg. 59)
9. Department representative (pg. 60)
10. temperature, air content, compressive strength (pg. 60)
11. True (pg. 61)
12. True (pg. 61)
13. 1,200 psi (pg. 69)
14. 200 (pg. 69)
15. anti-washout admixture or + 25% cement (pg. 70)
16. 40° F (pg. 70)
17. 50 CY or 30 minutes, whichever is greater (pg. 67 & 68)
18. True (pg. 76)
19. True (pg. 74)
20. True (pg. 78)

Review Question Answers

IV. PADOT Concrete Testing Procedures

1. False – Pub 19 Field Test Manual identifies those active and replaced (pg. 81)
2. False, as per Section 704.1(c)3 do not apply an aggregate correction factor (pg. 81)
3. first 1/3rd but not the initial concrete from the truck (pg. 83)
4. C 1064 (pg. 82)
5. 24 ± 2 hours (pg. 84)
6. every two (2) weeks (pg. 100)
7. tight fitting domed lids (pg. 84)
8. False – Identification shall include date molded, construction area, specimen type, series number, class of concrete, the contractor's concrete field technician and the Representative signatures and the contractor's concrete field technician certification number. (pg. 85)
9. volumetric method – roller meter (pg. 81)
10. 100 (pg. 99)
11. yearly or whenever the machine is moved (pg. 99)
12. True (pg. 97)
13. Manufacturer's (pg. 100)
14. 15 minutes (pg. 83)
15. False (pg. 83)
16. False – volumetric method with roller meter (pg. 81)
17. True (pg. 82)
18. True (pg. 83)
19. 60° F - 80° F (pg. 97)
20. 70° F / 76° F, 28 (pg. 97)

II. Project Documentation

10. To calculate W/C ratio, both the water and the cementitious material must be in the same units

$$\text{Total water} = 304 \text{ gal} \times 8.33 \frac{\text{lbs}}{\text{gal}} = 2532 \text{ lbs.}$$

$$\text{W/C} = \text{total water} \div \text{total cementitious} = 2532 \text{ lbs} \div 5880 \text{ lbs} = 0.43$$

14. Surface moisture is given in lbs./cy. Correct for a 10 CY load

$$65 \frac{\text{lbs}}{\text{CY}} \times 10 \text{ CY} = 650 \text{ lbs surface moisture in the load}$$

$$\text{W/C} = (650 \text{ lbs} + 2048 \text{ lbs}) \div 6580 \text{ lbs} = 0.41$$

18. Because the W/C ratio difference between the mix being used and the Trial mix is only 0.01, you should be suspicious that adding 1 gal/CY may exceed the maximum W/C ratio. You need to determine the water in the mix being delivered and compare it to the Trial mix water. You can arrive at the answer in one of two ways with the given information

One way is to calculate the total mix water using the batched water and the aggregate surface moisture:

How many gal/CY of water are allowed in this load of concrete? 33.2 gal/CY

How many gal/CY of water are already in this load of concrete?

$$\begin{aligned} \text{Batched Water: } & 2118 \text{ lbs} \div 8.33 \text{ lbs/gal} = 254 \text{ gals} \\ & 254 \text{ gals} \div 10 \text{ CY} = 25.4 \text{ gal/CY} \end{aligned}$$

Surface Moisture in the Aggregates: 7.1 gal/CY

$$\text{Total Mixing Water: } 25.4 \text{ gal/CY} + 7.1 \text{ gal/CY} = 32.5 \text{ gal/CY}$$

How many gal/CY of water can be added to this load of concrete?

$$33.2 \text{ gal/CY} - 32.5 \text{ gal/CY} = \underline{0.7 \text{ gal/CY}}$$

Therefore, you can only add up to 0.7 gal/CY without exceeding the Maximum W/C ratio.

Another way is using a ratio comparison:

$$\frac{\text{W/C Trial}}{\text{Trial water}} = \frac{\text{W/C mix}}{\text{mix water}} \quad \frac{0.47}{33.2 \text{ gal/CY}} = \frac{0.46}{\text{mix water}}$$

$$\text{mix water} = (0.46 \times 33.2 \text{ gal/CY}) / 0.47 = 32.5 \text{ gal/CY}$$

$$\text{Trial water} - \text{mix water} = 33.2 - 32.5 = \underline{0.7 \text{ gal/CY}}$$

19. **Step 1:** Calculate the SSD weight of coarse aggregate by dividing the coarse aggregate Scale weight by the surface moisture, expressed as a decimal, plus 1.

$$\text{SSD weight of the coarse aggregate} = \frac{\text{Scale weight of coarse aggregate}}{\text{surface moisture as decimal} + 1}$$

$$\frac{17,848 \text{ lbs}}{1.008} = 17,706 \text{ lbs}$$

- Step 2:** Determine surface moisture in the coarse aggregate by subtracting the SSD weight of the coarse aggregate from the coarse aggregate Scale weight.

$$17,848 \text{ lbs} - 17,706 \text{ lbs} = 142 \text{ lbs}$$

- 20.

Batched Mixing Water	1880 lbs
Fine Aggregate Scale Weight	12200 lbs
Fine Aggregate Moisture	4.8%
Coarse Aggregate Scale Weight	17709 lbs
Coarse Aggregate Moisture	0.9%
Total Cementitious Material	5870

$$\text{Determine the SSD weight of the fine aggregate} = \frac{12200 \text{ lbs}}{1.048} = 11641 \text{ lbs}$$

$$\text{Surface moisture in the fine aggregate} = 12200 \text{ lbs} - 11641 \text{ lbs} = \underline{559 \text{ lbs}}$$

$$\text{Determine the SSD weight of the coarse aggregate} = \frac{17709 \text{ lbs}}{1.009} = 17551 \text{ lbs}$$

$$\text{Surface moisture in the coarse aggregate} = 17709 - 17551 = \underline{158 \text{ lbs}}$$

$$\text{Determine the Total Water in the mix: } 1880 \text{ lbs} + 559 \text{ lbs} + 158 \text{ lbs} = \underline{2597 \text{ lbs}}$$

$$\text{Determine total cementitious material: } \underline{5870 \text{ lbs}}$$

$$\text{Calculate W/C Ratio: } \frac{2597 \text{ lbs of water}}{5870 \text{ lbs of cementitious}} = \underline{0.44}$$

Appendix I

Pub 408/2020 Change 5 Section 704

Pg. 112 - Pg. 132

PUB 536 (9-22)

Concrete Technician Certification Program

Pg. 133 - Pg. 146

SECTION 704—CEMENT CONCRETE

704.1 GENERAL—

(a) Description. Furnish the indicated class of cement concrete according to the requirements of Table A. Cement concrete is a mixture of portland cement, fine aggregate, coarse aggregate, water and air-entraining admixture, with or without water reducing admixture, retarding admixture, or supplementary cementitious material (SCM).

The methods of producing concrete referred to in these Specifications are defined as follows:

1. Plant Mixed Cement Concrete. Concrete proportioned and mixed in either a stationary, commercial, and central plant or a stationary plant located near the project. Concrete is delivered to the work site by truck, agitator truck, or mixer truck.

2. Truck Mixed Cement Concrete. Concrete prepared by dry batching in a proportioning plant and placing the dry ingredients in a truck mixer. Measured water is then added to the truck drum from the plant water system and the concrete is mixed in the truck at the plant. Mixing is not allowed en-route to or at the work site.

3. Volumetric Mixed Cement Concrete. Concrete proportioned and mixed in a truck-mounted mobile mixer. The unit is capable of proportioning concrete ingredients from self-contained bins and mixing the materials with measured water in a self-contained mixer. The concrete is mixed and discharged at the work site.

(b) Material.

- Cement—Section 701
- Fine Aggregate, Type A—Section 703.1
- Coarse Aggregate, Type A, maximum size AASHTO No. 467, No. 57, No. 67 or No. 8 (Stone, Gravel, or Slag)—Section 703.2
- Coarse Aggregate, Type A Lightweight, Section 703.2(a) 6
- Water—Section 720.1
- Admixtures—Section 711.3
- Supplementary Cementitious Material (SCM)—Section 724

Table A
Cement Concrete Criteria

Class of Concrete	Use	Cement Factor ⁽²⁾⁽⁴⁾ (lbs./cu. yd.)		Maximum Water Cement Ratio ⁽⁵⁾ (lbs./lbs.)	Minimum Mix ^(1,7) Design Compressive Strength (psi)				28-Day Structural Design Compressive Strength (psi)
		Min.	Max.		Days				
					3	7	28 ⁽⁸⁾	56 ⁽⁸⁾	
AAAP	Bridge Deck	560	640	0.45	—	3,000	4,000	—	4,000
AAA ⁽³⁾	Other	634	752	0.43	—	3,600	4,500	—	4,000
AAAP LW	Bridge Deck	600	730	0.45	---	3,000	4,000	---	4,000
AA	Slip Form Paving	587	752	0.47	—	3,000	3,750	—	3,500
AA	Paving	587	752	0.47	—	3,000	3,750	—	3,500
AA	Accelerated ⁽⁶⁾	587	800	0.47	—	—	3,750	—	3,500
AA	Structures and Misc.	587	752	0.47	—	3,000	3,750	—	3,500
AA LW		587	752	0.47	---	3,000	3,750	---	3,000
ASC ⁽⁹⁾		587	846	0.47	---	---	4,000	---	4,000
A		564	752	0.50	—	2,750	3,300	—	3,000
C		394	658	0.66	—	1,500	2,000	—	2,000
HES		752	846	0.40	3,000	—	3,750	—	3,500

- (1) Test Procedures: Slump—AASHTO T 119; Compressive Strength—PTM No. 604, or Maturity Meter Method—PTM No. 640. The upper age limit and lower age limit are defined by the values listed for 7-day and 28-day compressive strength.
- (2) For use in miscellaneous or structural concrete, if the Fineness Modulus (FM) is between 2.3 and 2.5, increase the minimum cement factor for the class of concrete 47 pounds per cubic yard. This requirement may be waived after adequate strength data is available and analyzed according to the mix-design section in ACI 211.
- (3) AAA concrete is not allowed to be used for new bridge decks.
- (4) For exception, see Section 704.1(c). Cement factor may be increased to a maximum of 690 pounds per cubic yard with the approval of the DME/DMM.
- (5) If a portion of the cement is replaced by SCM, use a water to cement plus SCM ratio by weight. The minimum water cement ratio for AAAP is 0.40 pounds per pounds.
- (6) For accelerated cement concrete, submit mix design, as specified, Section 704.1(c), having a minimum target value compressive strength of 1,500 pounds per square inch at 7 hours if tested according to PTM No. 604. (1,500 pounds per square inch at 7 hours is for mix design acceptance only). The required compressive strength for opening to traffic is specified in Section 501.3(q).
- (7) Trial Mix Designs for Class AAAP, AAAP LW, ASC and all concrete paving mixtures are required to meet a minimum 28-day compressive strength overdesign requirement of 28-day Minimum Mix Design Compressive Strength plus 500 pounds per square inch.
- (8) DME/DMM may accept mix designs based on the 56-day strength based on qualification testing.
- (9) For accelerated structural cement concrete, submit mix design, as specified in Section 704.1(c), having a minimum target value compressive strength of 3,500 pounds per square inch at 24 hours and 3,000 pounds per square inch to open to traffic when tested according to PTM No. 604.

1. Density of Material. Except for admixtures, use the following material densities (unit weights) if proportioning cement concrete:

Type of Material	Density
Water	62.4 pounds per cubic foot
Cement	94.0 pounds per cubic foot
Fine Aggregate	Based on bulk specific gravity as specified in Section 704.1(b)2
Coarse Aggregate	
Stone or Gravel	Based on bulk specific gravity as specified in Section 704.1(b)2
Slag	Based on field tests as specified in Section 704.1(b)2
Lightweight	Based on bulk specific gravity as specified in Section 704.1(b)2
SCM	Based on the LTS Tests

2. Specific Gravity of Aggregates. For fine and coarse aggregates, use the bulk specific gravity (saturated, surface-dry basis) listed in Bulletin 14.

For lightweight aggregate use the bulk specific gravity value (saturated surface-dry basis) listed in Bulletin 14, or the SSD gravity provided by the lightweight aggregate if purchased. As an alternative, the producer may run the SSD test and absorption with District Materials unit present.

If slag is used, test at the site to determine its loose-struck unit weight, solid volume per cubic yard, and bulk specific gravity factor (saturated surface-dry basis). Establish the concrete proportions based on the bulk specific gravity factor determined by the test. Check the unit weight of the slag daily to maintain the established solid-volume proportions.

3. Adjustment of Weight of Free Water. Adjust the batch weight of the aggregate to compensate for the free water on the aggregate. Base this adjustment on tests of representative samples taken from aggregate stockpiles.

4. Batching. For plant and truck mixed cement concrete, batch by weight. For volumetric mixed cement concrete, batch by volume.

(c) Design Basis.

1. General. Compute and prepare concrete mix designs according to ACI 211. For AAAP, determine the aggregate gradation for the mix design according to PTM No. 528. This does not apply to AAAP with #8's. Base concrete mix designs on the materials to be used in the work.

Overdesign strengths will be a minimum of 1,000 pounds per square inch except for AAAP, AAAP LW, AA Paving, and ASC which will be 500 pounds per square inch.

Make trial mixtures for each class of concrete and mold and cure test specimens. If the requirements of Table A cannot be achieved, furnish other acceptable materials or make necessary changes in the mixing procedure to conform to the specified requirements. Notify the DME/DMM at least 3 days in advance of preparing trial mixtures.

At the start of construction, mix a full-sized batch using the type of mixer and the mixing procedure planned for the project. Use this batch to provide the basis for final adjustment of the accepted design.

Mixture qualifications testing of Anti-Washout concrete according to PTM No. 641 to determine the maximum loss and required anti-washout admixture dosage may be conducted at an accredited lab or by the ready-mix producer with oversight from a technical representative from the admixture supplier. Trial batching for determination and verification of other design requirements must be performed by the ready-mix producer as specified in Section 704.1(c). Document the test results from the mixture qualification testing on the mix design before submitting for Department review.

2. Cement Factor. For all classes of concrete, use the minimum cement factor (cement, blended cement, or cement and SCM(s) combined) specified in Table A, except as follows:

Portland cement may be replaced with SCM(s) provided the maximum replacement by mass percentages in Table G, Prevention Level Z are not exceeded. The maximum limit of the cement factor may be waived if SCM(s) is/are added to the mix provided the portland cement portion does not exceed the maximum cement factor specified.

For AAAP and AAAP LW cement concrete, replace Type I or Type II portland cement with SCM (silica fume, flyash or slag cement) weighing as much as or more than the portland cement replaced. The percentages of SCM applicable to AAAP concrete are as shown below. Limit SCM to not more than two of the three SCMs listed below in one mix design as long as one of the SCM supplements meets the minimum percentage of replacement.

Cement factor must include at least one of the following as a replacement for a portion of the cement:

Slag Cement (Grade 100 or higher)	25% (min)
Flyash (Type C or Type F)	15% (min)
Silica Fume	5%-10%

3. Air Content. Design cement concrete to have an air content of 6.0% in the plastic state. Design AAAP and AA(pave) concrete mixes to have an air content of 7.0% in the plastic state. Obtain the air content through the addition of a solution of an air-entraining admixture as specified in Section 704.1(e)4. Use the quantity of air-entraining admixture necessary to maintain the plastic concrete air content, determined according to AASHTO T 152 (DO NOT APPLY AN AGGREGATE CORRECTION FACTOR) for stone and gravel and AASHTO T 196 (DO NOT APPLY AN AGGREGATE CORRECTION FACTOR) for slag or lightweight coarse aggregate, within a tolerance of $\pm 1.5\%$ during the work. The plastic concrete air content includes entrapped and entrained air.

If the hardened concrete exhibits deficiencies or the Representative suspects the hardened concrete to have deficiencies, and, if directed, determine the percent of entrained air in the hardened concrete according to PTM No. 623. Voids greater than 0.2 mils and less than 40 mils in their smallest dimension are considered entrained air. Voids 40 mils or more in diameter are considered entrapped air. The entrained air in the hardened concrete must be between 3.5% and 7.5%, inclusive. For AAAP and AA(pave) mixes, the entrained air in the hardened concrete must be between 4.5% and 8.5% inclusive.

4. Mix Design Acceptance. Submit a copy of each completed mix design to the Representative before its use in the work. The Department reserves the right to review all design through plant production before its use in Department work at no additional cost to the Department. The concrete design submitted for review is required to comply with the specified concrete class requirements, supported by slump, air content, and compressive strength test data according to ACI 211.

The Department will accept concrete designs based on the 7-day strength tests (Class High Early Strength (HES) may be accepted based on 3-day strength tests); however, conduct 28-day tests to show the potential of the design mix. The Department may also accept designs based on the 28-day tests.

Design AAAP cement concrete mixtures to achieve slow strength gain. Adjust component proportions with an objective of attaining a 28-day to 7-day compressive strength ratio during mix design greater than or equal to 1.20. A PennDOT inspector will witness the compressive strength tests. The 1.20 ratio is for mix design purposes only and not to be utilized as an acceptance factor during production. In no case will the Department accept any mixture during design which fails to meet a minimum 28-day to 7-day compressive strength ratio of 1.20.

Additional criteria for mix design acceptance of AAAP concrete are as follows:

The producer is required to complete the following tests before mix design submittal and approval.

- **Permeability** – Design the concrete mixture to meet a target chloride ion penetration of Low, Very low, or Negligible after a 56 day or less curing period according to AASHTO T 277 or AASHTO T 358.

The DME/DMM has the option of accepting mix designs with a chloride ion penetration of Moderate, however, the chloride ion penetration must meet one of the following:

AASHTO T 277, Table 1, not to exceed 2,800 coulombs; or

AASHTO T 358, Table 1, not to exceed 15.6k Ω -cm for 4-inch by 8-inch cylinders and 12.3 k Ω -cm for 6-inch by 12-inch cylinders.

- **Shrinkage (Microstrain)** – The 28-day shrinkage according to ASTM C157 is not to exceed 500 microstrain unless approved up to 550 microstrains by the DME/DMM. Wet cure specimens in the lab for 14 days before beginning the 28-day shrinkage testing (42 total days).

If permeability and shrinkage testing have been met for AAAP with #57's, these tests are not required for AAAP with #8's, provided the aggregates are from the same source.

A higher-class concrete may be used in place of an indicated lower-class concrete if the higher-class concrete

conforms to all the requirements of the indicated lower class, and if approved by the Department.

5. Lightweight Cement Concrete (AAP LW and AA LW). Compute and prepare concrete mix designs according to ACI 211.2. Design lightweight cement concrete to have a range of Equilibrium Density of 110 pounds per cubic feet to 117 pounds per cubic feet with a target of 115 pounds per cubic feet, when tested according to ASTM C567

Supply the following information to the District Materials Unit at least two weeks before conducting trial mixes:

- Approximate absolute volume of coarse aggregate (cubic feet)
- Suggested coarse aggregate factor (CAF) (pounds per cubic yard)
- Oven-dry loose weight of coarse aggregate (pounds per cubic feet)
- Specific gravity factor
- Percent absorption

Store and use lightweight aggregates in a stable, uniform, saturated condition to ensure the aggregate, if batched, is at a moisture greater than saturated surface dry (SSD). Use the same source of aggregates and mix design throughout the entire project.

Plastic density can be used for field acceptance once a correlation between plastic density and equilibrium density is established. Equilibrium density as measured according to ASTM C567.

Entrained air content can be determined by the unit weight method according to ASTM C138. Once established, a correlation between air content as tested according to ASTM C 173 and the unit weight method can be made.

6. Sulfate Resistance Concrete. Design sulfate resistant concrete according to ACI 201.2.

(d) Testing and Acceptance.

1. QC Plan. Prepare a QC Plan as specified in Section 106.03 and submit it for review before the start of the project and at least annually thereafter. Include in the QC Plan testing frequencies and action points to initiate corrective measures. Do not start work until the Department has reviewed the QC Plan. Furnish a copy of the QC Plan to be maintained in the Department's project field office.

1.a Field Operation QC Plan. Prepare a field operation QC Plan for the Representative's review, on Form CS-704, to evaluate concrete field operation. Submit the field operation QC Plan at the Pre-construction conference or at least 3 weeks before the first concrete pour. Describe the construction equipment, personnel, and methods necessary to construct and test concrete courses for all structural elements. Include testing frequencies and action points to initiate corrective measures. Do not establish action points at either the upper or lower specification limits.

2. Concrete Technician. Provide, and assign to the work, a concrete technician properly instructed and trained to develop the concrete design, to control the quality and gradation of aggregates used, to perform required concrete tests, and to control the operations and concrete deliveries so the completed mixture conforms to the specifications at the point of placement.

The Department's concrete plant Inspector will not allow concrete considered unacceptable to be shipped to the project. The Inspector will not assume, by act or by word, any responsibility for batch control adjustments; calculations; or for setting of dials, gauges, scales, or meters. Failure of the Inspector to reject unacceptable concrete will not relieve the Contractor's obligation to provide concrete conforming to the specifications.

2.a Concrete Field Testing Technician. Provide, and assign to the work during placement of material, a PennDOT certified field testing technician, meeting the requirements according to Publication 536, to perform the required acceptance testing. The technician must carry a valid PennDOT certification card during placement of material.

2.b. Concrete Finisher Certification. Provide ACI certified Flatwork Finishers, ACI certified Advanced Flatwork Finishers, or National Ready-Mix Concrete Association (NRMCA) certified Exterior Flatwork Finishers to control finishing of each concrete placement operation for all concrete finishing work associated with the following Sections:

501 502 505 506 516 518

704 – 5

Change No. 5

519	520	523	525	527	530
540	545	548	623	630	633
640	641	658	676	695	852
910	1001	1040	1042	1090	

A minimum of 60 percent of the finishers finishing concrete on each concrete placement must possess at least one of the identified flatwork finisher certification types, unless approved by the Representative. Provide proof of flatwork finisher certification to the Representative before concrete placement.

3. Testing Facilities and Equipment. Provide sufficient thermometers, air meters conforming to AASHTO T 196 and T 152, and slump cones conforming to AASHTO T 119 for each separate project operation as needed. In the presence of the Inspector, calibrate all air meters a maximum 2 weeks before beginning concrete placement. Recalibrate all air meters, in the presence of the Inspector, every 2 weeks during concrete placement. Have back-up equipment available to ensure no tests are missed. Provide sufficient 6-inch by 12-inch cylinder molds and tight-fitting domed caps (PTM No. 611) for QC, acceptance, verification, and QA samples. Provide sufficient incidental equipment such as wheelbarrows, shovels, and scoops as needed.

Provide acceptable means to conduct compressive strength testing using a compression machine and capping device conforming to PTM No. 604. Provide a curing tank conforming to PTM No. 611. Provide curing boxes, or other acceptable equipment, conforming to PTM No. 611 and capable of maintaining the air temperature immediately adjacent to the field-cured cylinders in the range of 60F to 80F for the first 24 ± 2 hours. Provide sufficient high-low thermometers or other temperature recording devices to monitor the temperatures next to the test cylinders. If required, cap cylinders at the testing site under the Representative's supervision.

If using the maturity method to estimate concrete compressive strength, provide one or more maturity meters and a sufficient number of temperature sensors conforming to PTM No. 640. Note: Casting concrete cylinders according to PTM 611 is recommended in case maturity meter equipment malfunctions.

Maintain all equipment used for testing in an operable condition. Using an independent agency acceptable to the Department, calibrate scales, balances, and the compression machine at least once per year. Recalibrate the compression machine whenever it is relocated. Maintain accurate records of calibration. If the compression machine is out of tolerance or malfunctions, return it to working order within 24 hours or supply a back-up machine until the problem is corrected.

Provide the necessary facilities for inspection, including a plant office as specified in Section 714.5(a), with the exception of a minimum floor space of 120 square feet.

4. QC Testing. Perform QC testing according to the reviewed QC Plan and as follows:

4.a QC Sampling and Testing of Plastic Concrete. Select an appropriate slump target value and range that will provide a workable mix for the construction element. The Contractor's technician must have a copy of the Department reviewed QC Plan in their possession during testing and must be aware of the target slump for the structural element being placed. Do not exceed the following slump upper limits:

Type of Mix	Slump Upper Limit
without water reducing admixtures	5 inches
with water reducing admixtures	6 1/2 inches
with high range water reducing admixtures (superplasticizers)	8 inches
mixes specified in Section 704.1(h) (except tremie concrete as specified in Section 1001.2(j))	2 1/2 inches
AAAP (regardless of admixtures used)	5 1/2 inches
AAAP LW (regardless of admixtures used)	6 inches

Perform plastic concrete slump, air, density (for AAAP LW and AA LW) and temperature tests on the first three consecutive trucks at the beginning of concrete placement operations or after a significant stoppage such as plant or equipment breakdown to determine if material control has been established. Material control is established when all test results of concrete slump, air, and temperature for three consecutive trucks are determined to be within the established action points. Obtain samples of fresh concrete according to PTM No. 601. Perform slump tests according to AASHTO T 119, air content tests according to AASHTO T 152 (DO NOT APPLY AN AGGREGATE CORRECTION FACTOR) or T 196 (DO NOT APPLY AN AGGREGATE CORRECTION FACTOR) (AASHTO T196 for AAAP LW and AA LW), temperature tests according to ASTM C1064, and density testing according to

AASHTO T 121(for AAAP LW and AA LW) Report test data to the concrete technician promptly in order to facilitate necessary changes. Continue testing consecutive trucks until material control is established. Once material control is established, the frequency of testing may be reduced to a minimum of one test per 50 cubic yards. Select concrete batches for sampling according to the reviewed QC Plan or as directed by the Inspector. Notify the Inspector if sampling and QC testing are to be performed. The Inspector will witness the sampling and QC testing. If a QC test fails to conform to the specified requirements or exceeds the upper or lower action points included in the reviewed QC Plan, increase the testing frequency to every truck until material control has been reestablished.

Maintain the cement concrete consistency within 1 1/2 inches of the selected target slump value (target range). If the upper slump limit is exceeded on any slump test, the Contractor's technician shall reject the cement concrete. If any slump test result falls outside the target range and has not exceeded the upper limit, immediately perform the air content and temperature tests. If the air content and concrete temperature is within the specified limits, the Contractor may incorporate the material into the work provided a full set of quality control and acceptance cylinders are molded in addition to the cylinders made for the originally selected PTM No. 1 sample location, for compressive strength testing according to PTM No. 611 and PTM No. 604. If one or more truckloads of cement concrete exceeds the slump target range, make additional quality control and acceptance cylinders from each truck. Use the lowest compressive strength cylinders for acceptance of the lot.

Do not incorporate concrete into the work that does not conform to the specified requirements.

4.b QC Compressive Strength Test Cylinders. From the same sample of concrete selected for acceptance testing as specified in Section 704.1(d)5, mold a sufficient number of concrete QC cylinders to be tested for 3-day or 7-day compressive strength, 14-day compressive strength (AAAP), 28-day compressive strength, form removal strength, and loading strengths, as specified.

If using the maturity method to estimate concrete compressive strength, mold two or more cylindrical specimens for temperature history recording and embed a temperature sensor at the vertical and horizontal center of the cylindrical specimen and activate the maturity meter or data acquisition equipment to record the temperature history for the 3-day, 7-day, 14-day (AAAP), 28-day, and, as required, 56-day compressive strength analysis.

Field cure cylinders according to PTM No. 611, Section 12.2, for the specified curing period. After concrete curing is discontinued, QC cylinders may be relocated to a preapproved, acceptable, secure area, to protect them from damage. Provide maintenance and security for the area at no additional cost to the Department. The secure area must be easily accessible for inspection at all times. Continue to provide the same field cure and protection from the elements on all surfaces of the cylinders as that provided for the in-place concrete the cylinders represent until the cylinders are tested for compressive strength. Remove cylinders from molds at the same time formwork is removed.

Perform QC testing for 3-day or 7-day compressive strength, 14-day compressive strength (AAAP), 28-day compressive strength, and form removal and loading strengths according to PTM No. 611. If using the maturity method to estimate concrete compressive strength, perform QC testing using the procedure to estimate in place strength according to PTM No. 640. Do not use the maturity method for determining acceptance strength, typically at 28 days. Notify the Inspector when QC testing is to be performed. The Inspector will witness the QC testing.

Unless otherwise directed, use QC test results for 3-day or 7-day compressive strength and form removal and loading compressive strength to determine whether to place additional concrete in areas that will be impacted by the lot of concrete represented by the QC cylinders. Acceptable QC compressive strength test results do not relieve the Contractor's responsibility for providing concrete conforming to the 28-day minimum mix design compressive strength acceptance requirements as specified in Section 704.1(d)5.

For AAAP and Prevention Level Z mixes, in addition to the samples required above, mold two concrete cylinders and cure them under QC conditions for 56 days. After 56 days test the two cylinders for compressive strength and report the compressive strengths.

4.b.1 3-Day or 7-Day or 14-Day (AAAP) QC Compressive Strength. If the average 3-day (HES concrete only) or average 7-day QC compressive strength test result is greater than or equal to the minimum mix design compressive strength requirement specified in Table A, the Contractor may discontinue the field cure on the lot of concrete represented by the QC cylinders unless otherwise directed. If the average 14-day (AAAP) QC compressive strength test result is greater than or equal to 3,500 pounds per square inch, the Contractor may discontinue the field cure on the lot of concrete represented by the QC cylinders, unless otherwise directed.

If the average 3-day (HES concrete only) or average 7-day QC compressive strength test result is less than the minimum mix design compressive strength requirement specified in Table A, continue the field cure on the lot of concrete represented by the QC cylinders until the specified 28-day minimum mix design compressive strength is obtained, or for a maximum of 28 days. If the average 14-day (AAAP) QC compressive strength test result is less than 3,500 pounds per square inch, continue the field cure on the lot of concrete represented by the QC cylinders, until the

specified 28-day minimum mix design compressive strength is obtained, or for a maximum of 28 days.

4.b.2 28-Day QC Compressive Strength. If the average 28-day QC compressive strength test result is greater than or equal to the 28-day minimum mix design compressive strength specified in Table A, acceptance of the concrete lot will be based on the compressive strength testing of acceptance cylinders as specified in Section 704.1(d)5.

If the average 28-day QC compressive strength test result is less than the 28-day minimum mix design compressive strength specified in Table A, but greater than or equal to the 28-day structural design compressive strength specified in Table A, acceptance of the concrete lot will be based on the compressive strength testing of acceptance cylinders as specified in Section 704.1(d)5, and as follows:

- Perform an investigation of procedures for material sampling, testing, and concrete cylinder molding and curing, and evaluate the concrete mix design and specification compliance to determine possible causes for the QC test result not meeting the specified minimum mix design compressive strength.
- Implement corrective actions as required.
- Submit an investigation report to the District Executive within 10 working days for review and approval.

If the average 28-day QC compressive strength test result is less than the 28-day structural design compressive strength specified in Table A, acceptance of the concrete lot will be based on compressive strength testing of cores obtained from the lot of concrete represented by the QC cylinders as specified in Section 110.10(d).

5. Acceptance Testing. Determine the lot size(s) for material acceptance according to Table B and notify the Representative. Establish new lots daily for each class of concrete. Lots must be specific to a particular structural element, except for incidental concrete items. The Contractor may use a lot combining structural elements if allowed in writing before concrete placement and if the following conditions are met:

- The total volume is 100 cubic yards or less.
- The combined structural elements are constructed using the same mix design concrete.
- The combined structural elements are cured using identical curing methods and conditions.

Cylinders (and cores if necessary) for this lot will represent all the combined elements.

TABLE B
Maximum Lot Size for Concrete Acceptance

Construction Area	Maximum Lot Size
Structural Concrete	100 cu. yd.
Pavement Concrete	500 cu. yd.
Pavement Patching Concrete	200 cu. yd.
Incidental Concrete	100 cu. yd.

The Representative will select sample locations for acceptance testing according to PTM No. 1 (n=1). Perform sampling and testing for acceptance in the presence of the Representative. Obtain samples of fresh concrete at the point of placement according to PTM No. 601. Perform concrete temperature tests. Perform air content tests according to AASHTO T 196 or T 152. Reject all concrete not conforming to the specification requirements at the point of placement.

If the results of plastic concrete testing conform to the specification requirements, mold a sufficient number of acceptance cylinders according to PTM No. 611 from the same sample of concrete taken for slump, air content, and temperature determination. Standard cure acceptance cylinders according to PTM No. 611, Section 12.1, for 28 days and 56 days (AAP and Prevention Level Z) at an acceptable location. Conduct 28-day and 56-day (AAP and Prevention Level Z mixtures only) compressive strength testing of two acceptance cylinders according to PTM No.

604. If for any reason two testable acceptance cylinders are not available for compressive strength testing, obtain two cores of the representative concrete within 3 working days as directed, and at no additional cost to the Department. Conduct 28-day compressive strength testing of the cores according to PTM No. 604.

The Department will accept the lot of concrete if the average 28-day acceptance cylinder compressive strength test result is greater than or equal to the 28-day minimum mix design compressive strength specified in Table A and if the average 28-day QC compressive strength requirements specified in Section 704.1(d)4.b have been met.

If the average 28-day acceptance cylinder compressive strength test result is less than the 28-day minimum mix design compressive strength specified in Table A, acceptance of the concrete lot will be based on the procedures as specified in Section 110.10.

6. Verification Testing. The Representative will perform verification testing on the initial acceptance sample for each type of concrete specified in Table B and a minimum of one verification test for every ten acceptance samples thereafter. Verification testing will consist of testing for temperature, air content, and compressive strength. Verification tests will be performed on concrete from the same sample used for acceptance testing.

The Representative will obtain the temperature of the sample concurrently with the acceptance sample. Immediately after an acceptable air content test result for acceptance is obtained, the Representative will test the sample for air content according to AASHTO T 196 or T 152 using the same air meter.

The Representative will mold two verification cylinders according to PTM No. 611. Standard cure the verification cylinders along with the acceptance cylinders according to PTM No. 611, Section 12.1, for 28 days. The Representative will conduct 28-day compressive strength testing of the verification cylinders according to PTM No. 604. Conduct the testing at the same time the acceptance cylinders are tested and using the same equipment.

Verification test results will be compared to the associated acceptance test results and will not be used to determine acceptance of the lot. If there is a difference in test results of more than 5F for temperature, 1.0% for air content, or 500 pounds per square inch for compressive strength, the Representative will immediately review the testing procedures, equipment, and personnel used in the acceptance testing and implement corrective measures to ensure the tests are performed within the prescribed tolerances. The Representative will record the acceptance test results, the verification test results and applicable corrective measures in the Concrete Inspector's Daily Record Book, Form CS-472.

7. QA Testing. The CMD QA personnel will obtain QA samples as part of the operation review process according to the QA Manual, Publication 25.

QA personnel will select concrete to be sampled. Obtain samples of fresh concrete at the point of placement according to PTM No. 601. Perform concrete temperature tests adjacent to those conducted by QA personnel. Perform air content tests according to AASHTO T 196 or T 152 with the air meter used for acceptance testing. QA personnel will perform air content tests according to AASHTO T 196 or T 152 with the backup air meter on the project. Immediately report all test results to the QA personnel. Reject all concrete not conforming to the specification requirements at the point of placement.

QA personnel will immediately perform an independent assurance evaluation of the temperature and air content test results. If the difference in test results is more than 5F for temperature or 1.0% for air content, the Representative will immediately review the testing procedures, equipment, and personnel used in the acceptance testing and implement corrective measures to ensure the tests are performed within the prescribed tolerances.

QA personnel will mold five QA cylinders from the selected sample according to PTM No. 611. Field cure the QA cylinders according to PTM No. 611, Section 12.2, for the specified curing period for the structural element the cylinders represent. After curing of the in-place concrete is discontinued, QA cylinders may be relocated to a pre-approved, acceptable, secure area, to protect them from damage. Provide maintenance and security for the area at no additional cost to the Department. The secure area must be easily accessible for inspection at all times. Continue to provide the same field cure and protection from the elements on all surfaces of the cylinders as that provided for the in-place concrete the cylinders represent until the cylinders are tested for 28-day compressive strength.

Conduct 28-day compressive strength testing on two QA cylinders according to PTM No. 604 using the same equipment used for acceptance and verification testing.

The Representative will forward the remaining three QA cylinders to the LTS for 28-day compressive strength testing according to PTM No. 604 and hardened air content testing according to PTM No. 623. Furnish packaging material and package cylinders under the direction and supervision of the Representative. Place the cylinders in individual containers cushioned with suitable material to prevent damage during shipment. The total weight of each container, cylinder and cushioning material must not exceed 50 pounds.

QA personnel will perform an independent assurance evaluation of the 28-day compressive strength test results. If the difference between the test results of the cylinders tested at the project site and the cylinders tested at the LTS

is more than 500 pounds per square inch, the Representative will immediately review the testing procedures, equipment, and personnel used in the acceptance testing and implement corrective measures to ensure the tests are performed within the prescribed tolerances.

(e) Measurement of Material.

1. Cement. AASHTO M 157 and as follows:

For plant and truck mixed concrete, measure by weight. The Contractor may measure the weight of the cement separately in an enclosed compartment in the aggregate hopper. The Contractor may measure the weight of the cement and discharge it simultaneously with the aggregates, except as specified in Section 106.05(c).

For volumetric mixed concrete, measure by volume.

2. Aggregates. AASHTO M 157 and as follows:

For plant or truck mixed concrete, measure by weight unless otherwise allowed. Base measurements on the material weight-volume relationship, as specified in Section 704.1(b)1.

For volumetric mixed concrete, measure by volume.

3. Water. AASHTO M 157 except as follows:

Use water-measuring systems capable of discharging the total quantity of measured water into the plant or truck mixer drum in a time not greater than one-fourth of the specified mixing time. For truck mixed concrete, do not add water from the truck water system. Add water only from the plant water measuring system.

4. Admixtures. Incorporate the air-entraining admixture solution into the batch with the mixing water using a suitable visual measuring device. If another type of admixture is used with an air-entraining admixture, add it in solution to another portion of the mix water, as directed, by an additional suitable visual measuring device, except high range water reducing and anti-washout admixtures will be added according to the manufacturer's recommendations.

Equip the measuring device with interlocks to prevent discharging during the charge cycle and to prevent charging during the discharging cycle. Provide a means to calibrate the measuring device to within $\pm 3\%$.

Dispense the air-entraining admixture solution into the batch from a bulk supply tank. For paving, and if directed, provide a bulk supply tank containing sufficient solution for the entire day's concreting operations.

On the dispensing system, provide device(s) capable of detecting and indicating the presence or absence of admixture flow. Agitate admixtures, as required, to insure consistency of the solution.

5. SCM. If the use of SCM is allowed by the specification, add separately and measure cumulatively as specified in Section 704.1(e)1.

(f) Mixing Conditions.

1. During Cool and Cold Weather. If concrete is to be placed at air temperatures below 40F, or if the local weather bureau forecasts air temperatures to descend to 40F or lower at any time during the 24-hour period following concrete placement, use an acceptable method to ensure the aggregate is free of frozen lumps and at a temperature of not less than 40F or more than 100F at the time of charging into the mixer. Heat mixing water, if necessary, but do not exceed 150F. Do not allow water with a temperature above 90F to come in contact with the cement until the cement has been mixed with the aggregates.

2. During Hot Weather. In hot weather, cool the aggregates and the mixing water as necessary to maintain the concrete temperature from 50F to 90F at the time of placement. For bridge deck concrete placement, maintain the concrete temperature from 50F to 80F at the time of placement. For accelerated concrete placement, maintain the concrete temperature from 50F to 100F at the time of placement.

3. Retarding Admixtures. The Contractor may use retarding admixtures, or may be directed to use retarding admixtures, if any of the following conditions are anticipated:

- rapid drying of the concrete as a result of low humidity
- high winds

- high air temperatures

Introduce the retarder into the concrete mixture as specified in Section 704.1(e)4. Adjust the proportions of the design as necessary but do not use the retarder to replace any portion of the specified volume of cement.

Use a retarder available in sufficient quantities to provide the required degree of retardation under the prevailing weather conditions at the time of concrete placement.

(g) Mix Designs Using Potentially Reactive Aggregate.

1. Definition of Terms.

1.a Alkalis. Oxides of sodium and potassium generally derived from Portland cement, but may also be available to concrete from other sources such as; admixtures, de-icing salts, and, in rare instances, aggregates. Alkalis are calculated according to AASHTO M 85.

1.b SCM. A siliceous or siliceous and aluminous material that possesses little or no cementitious value but will, in finely divided form and in the presence of moisture, chemically react with calcium hydroxide at ordinary temperatures to form compounds possessing cementitious properties. The term “SCM,” includes flyash, slag cement, silica fume, and metakaolin.

1.c Lithium Nitrate Admixtures. A lithium nitrate admixture as listed in Bulletin 15.

1.d Alkali-Aggregate Reaction. A chemical reaction in concrete between alkalis and certain constituents of some aggregates. The products of this reaction, under certain conditions, may cause deleterious expansion within the concrete.

1.e Alkali-Silica Reaction. An alkali-aggregate reaction involving certain siliceous aggregates and some calcareous aggregates containing certain forms of silica.⁽¹⁾

Note (1)—Siliceous substances known to react with alkalis are as follows: opal; chalcedony as a constituent of chert in carbonate rock or sand and gravel particles; tridymite and cristobalite, which are high temperature forms of silica found in andesite or rhyolite; acid glasses containing more than 65% silica; or intermediate glasses containing between 55% and 65% silica. Other siliceous substances that are potentially reactive with alkalis are strained quartz as a constituent of granite or granite gneiss and clay minerals as a constituent of graywackes, argillites, phyllites, and siltstones.

1.e.1. Determining Aggregate Reactivity.

1.e.1.a. Field Performance History. Field performance history according to AASHTO R 80, Section 6.1 of an aggregate may be used to establish the potential to contribute to deleterious ASR with the approval of the DME/DMM.

1.e.1.b Petrographic Examination. Petrography may be used to classify an aggregate as potentially reactive, but expansion testing is required to determine the extent of potential reactivity and the appropriate level of prevention.

1.e.1.c. Expansion Testing. Aggregates will be tested according to ASTM C1293 or AASHTO T 303 and listed in Bulletin 14. ASTM C1293 test results will be used to determine the reactivity level of an aggregate. Unless it is a new source, the AASTHO T 303 results will be used until ASTM C1293 testing is completed by the Department. The reactivity class of the aggregate will be used to determine the required level of prevention. If using aggregates with different reactivity levels, the highest reactivity level will be used for mitigation. If the expansion result for a coarse aggregate size is not listed in Bulletin 14, use of the expansion result from another coarse aggregate size listed in Bulletin 14 from the same source will be acceptable.

Use aggregates deemed potentially reactive only with cements or cement-SCM combinations as specified in Section 704.1(g)3. If one or both of the aggregates (coarse or fine) used in a mix is reactive, mitigation is required

as specified in Section 704.1(g)3. This requirement applies to all concrete used in paving or permanent structures on Department projects, including latex modified overlays and precast and prestress concrete products.

For new Type A aggregate sources which do not have LTS expansion listed, LTS will initially perform AASHTO T 303 to determine the reactivity class. Any new source with an expansion that indicates the aggregate is non-reactive (R0) will initially be listed with an expansion of 0.11% (R1) requiring ASR mitigation until ASTM C1293 testing by LTS is completed.

Sources will be tested on a 5-year cycle according to ASTM C1293. Testing will be performed by LTS. If the new test results change the mitigation level of the aggregates, mix designs must be started immediately and all designs must be completed within 90 days of receiving test results.

2. Selecting Preventive Measures for Alkali-Silica Reaction.

2.a Using the Concrete Prism Test (ASTM C1293) to Evaluate Preventive Measures.

2.a.1 Mixture Qualification. The concrete prism test may be used to evaluate the efficacy of SCMs or blended cements or both used with volumetric SCM replacements less than those specified in Section 704.1(g)2.c as a prescriptive remediation method and for all mixtures utilizing remediation with either metakaolin or a lithium nitrate admixture. If lithium nitrate admixtures are used, the admixture must be added to the mix water and necessary corrections made to account for the water in the admixture. If the expansion of concrete prisms is less than 0.04 percent after 2 years, the preventive measure will be deemed effective with the reactive aggregate(s).

For mixtures qualified using the preventive measure, substitutions of the cement (type for type), or SCM(s), type for type will be allowed provided the alkali limits as specified in Section 704.1(g)3 are not exceeded. Substitution of aggregates using the preventive measure is prohibited.

2.b Steps for Selecting Preventive Measures for Alkali Silica Reaction.

2.b.1 Determine the level of prevention by considering the reactivity class of the aggregate(s), classification of the structure type, and the associated risk level.

2.b.1.a Aggregate Reactivity. The degree of alkali silica reactivity of an aggregate will be determined as specified in Section 704.1(g).1.d.1.c and as indicated in Table C.

Table C
Classification of Aggregate Reactivity

Aggregate Reactivity Class	Description of Aggregate Reactivity	1-Year Expansion in ASTM C1293 (percent)	14-d Expansion in AASHTO T 303 (percent)
R0	Non-reactive	≤ 0.04	≤ 0.10
R1	Moderately reactive	>0.04 to ≤ 0.12	>0.10 to ≤ 0.30
R2	Highly Reactive	>0.12 to ≤ 0.24	>0.30 to ≤ 0.45
R3	Very Highly Reactive	>0.24	>0.45

2.b.1.b Risk of ASR. Determine the level of ASR risk occurring in a structure by considering the aggregate reactivity class in Table D.

Table D
Level of ASR Risk

Aggregate Reactivity Class	R0	R1	R2	R3
Level of ASR Risk	Risk Level 1	Risk Level 2	Risk Level 3	Risk Level 4

2.b.1.c Level of Prevention. The level of prevention is determined from Table E by determining the risk of ASR from Table D together with the class of structure from Table F.

Table E
Determining the Level of Prevention

Level of ASR Risk	Classification of Structure		
	S1	S2	S3
Risk Level 1	V	V	V
Risk Level 2	V	W	X
Risk Level 3	W	X	Y
Risk Level 4	X	Y	Z

Table F
Structure Classification

Structure Class	Consequences	Acceptability of ASR	Structure/Asset Type	Sections
S1	Safety and future maintenance consequences small or negligible	Some deterioration from ASR may be tolerated	Temporary structures. Inside buildings. Structures or assets that will never be exposed to water	620, 621, 624, 627, 628 643, 644, 859, 874, 930, 932, 934, 952, 953, and 1005
S2	Some minor safety, future maintenance consequences if major deterioration were to occur	Moderate risk of ASR acceptable	Sidewalks, curbs and gutters, inlet tops, concrete barrier and parapet. Typically structures with service lives of less than 40 years	303, 501, 505, 506, 516, 518, 523, 524, 525, 528, 540, 545, 605,607, 615, 618, 623, 630, 633, 640, 641, 658, 667, 673, 674, 675, 676, 678, 714, 852, 875, 910, 948, 951, 1001, 1025, 1040, 1042, 1043, 1086, 1201, 1210, 1230, and Miscellaneous Precast Concrete
S3	Significant safety and future maintenance or replacement consequences if major deterioration were to occur	Minimal risk of ASR acceptable	All other structures. Service lives of 40 to 75 years anticipated.	530, 1001, 1006, 1031, 1032, 1040, 1080, 1085, 1107, MSE walls, Concrete Bridge components, and Arch Structures

2.c Minimum Levels of Supplementary Cementitious Materials (SCM) based on Level of Prevention.
Utilize a minimum mass replacement level from Table G below.

Table G
Minimum Replacement Level of SCM (percentage by mass of cementitious material ⁽¹²⁾)

Type of SCM ⁽¹⁾	Alkali Level of SCM (% Na ₂ O _e) ^{(2), (3)}	Level V ⁽⁴⁾	Level W	Level X	Level Y	Level Z ^{(5), (11)}
Class F or C flyash ⁽⁶⁾	≤ 3.0	–	15	20	25	35
Class F or C flyash ⁽⁶⁾	>3.0 to ≤ 4.5	–	20	25	30	40
Slag Cement	≤ 1.0	–	25	35	50	65
Silica Fume ^{(7), (8), (9), (10)}	≤ 1.0	–	1.2 x LBA	1.5 x LBA	1.8 x LBA	2.4 x LBA

Notes:

- (1) The SCM may be added directly to the mixture, be a blended cement, or a combination of a blended cement and a SCM.
- (2) Where combinations of Class C and Class F are used, the alkalinity of the Class C flyash may exceed 4.5% provided the calculated alkalinity of the combination, based on the mass replacement, does not exceed 4.5%
- (3) If two or more SCMs (including SCMs in blended cements) are used in combination, the minimum mass replacement levels given in Table G for the individual SCMs may be reduced provided the sum of the parts of each SCM is greater than or equal to one. For example, if silica fume and slag are used together, the silica fume level may be reduced to one-third of the minimum silica fume level given in the table provided the slag level is at least two-thirds of the minimum slag level required.
- (4) No remediation is required at prevention Level V unless otherwise indicated by specification, e.g. Section 530.
- (5) The alkali level of the concrete may be limited as specified in Section 704.1(g) 2.c.1
- (6) The CaO must be limited to a maximum of 18%.
- (7) The SiO must be greater than or equal to 85%
- (8) The minimum level of silica fume is calculated based on the alkali (Na₂O_e) content of the concrete contributed by the Portland cement and expressed in LBA (lbs./cy) by multiplying the cement content of the concrete in lbs./cy by the alkali content of the cement divided by 100. For example, for a concrete containing 500 lbs./cy with an alkali content of 0.81% Na₂O_e, the value of LBA = 500 x 0.81/100 = 4.05 lbs./cy. For this concrete, the minimum replacement level of silica fume for Level Y is 1.8 x 4.05 = 7.3 percent.
- (9) Regardless of the calculated value, the minimum level of silica fume should not be less than 7 percent if it is the only method of prevention.
- (10) It is impractical to modify a mix design frequently during production based on the actual alkali limit of the cement used, therefore, where silica fume is used as the sole method of prevention, the maximum assumed alkali limit of the cement must be indicated on the mix design.
- (11) Additional options for prevention Level Z are specified in Section 704.1(g)2.c.1 and Table H
- (12) The use of high levels of SCMs in concrete may increase the risk of problems due to deicer salt scaling if the concrete is not properly proportioned, finished, and cured.

2.c.1 The minimum replacement levels in Table G are appropriate for use with portland cements of moderate to high alkali contents (0.70 to 1.25 percent Na₂O_e). Table H provides an alternative approach for utilizing SCMs if the alkali content of the Portland cement is less than or equal to 0.70%.

Table H
Adjusting the Minimum Level of SCM if using low alkali Portland cement

Cement Alkalis (% Na ₂ O _e)	Level of SCM
≤ 0.70	Reduce the minimum amount of SCM given in Table G by one prevention level. ⁽¹⁾
(1) The replacement levels should not be below those given in Table G for prevention Level W regardless of the alkali content of the Portland cement.	

2.c.2 Requirements for Prevention Level Z. Where prevention Level Z is required, use the minimum level of SCM shown in Table G or use the minimum level of SCM and the maximum concrete alkali content indicated in Table I.

Table I
Using SCM and Limiting the Alkali Content of the Concrete

Prevention Level	SCM as sole prevention	Maximum Alkali Content, (lbs./cy) and Minimum SCM Level
Z	Level Z from Table G	Maximum Alkali Level Content: 3.0 AND minimum SCM Level Y from Table G

3. Cement/Cement-SCM Requirements. For use with aggregate deemed potentially reactive as specified in Section 704.1(g), provide Portland cement, blended hydraulic cement, or Portland cement-SCM combinations as specified in Section 704.1(b) and the following:

3.a Portland Cement. Conforming to the optional chemical requirement in AASHTO M 85 for a maximum alkali content of 1.25% Na₂O_e if used for ASR prevention.

3.b Blended Hydraulic Cement. Type IS or IP, AASHTO M 240 (ASTM C595). From a manufacturer listed in Bulletin 15.

3.c. ASR Mitigation Flowchart.

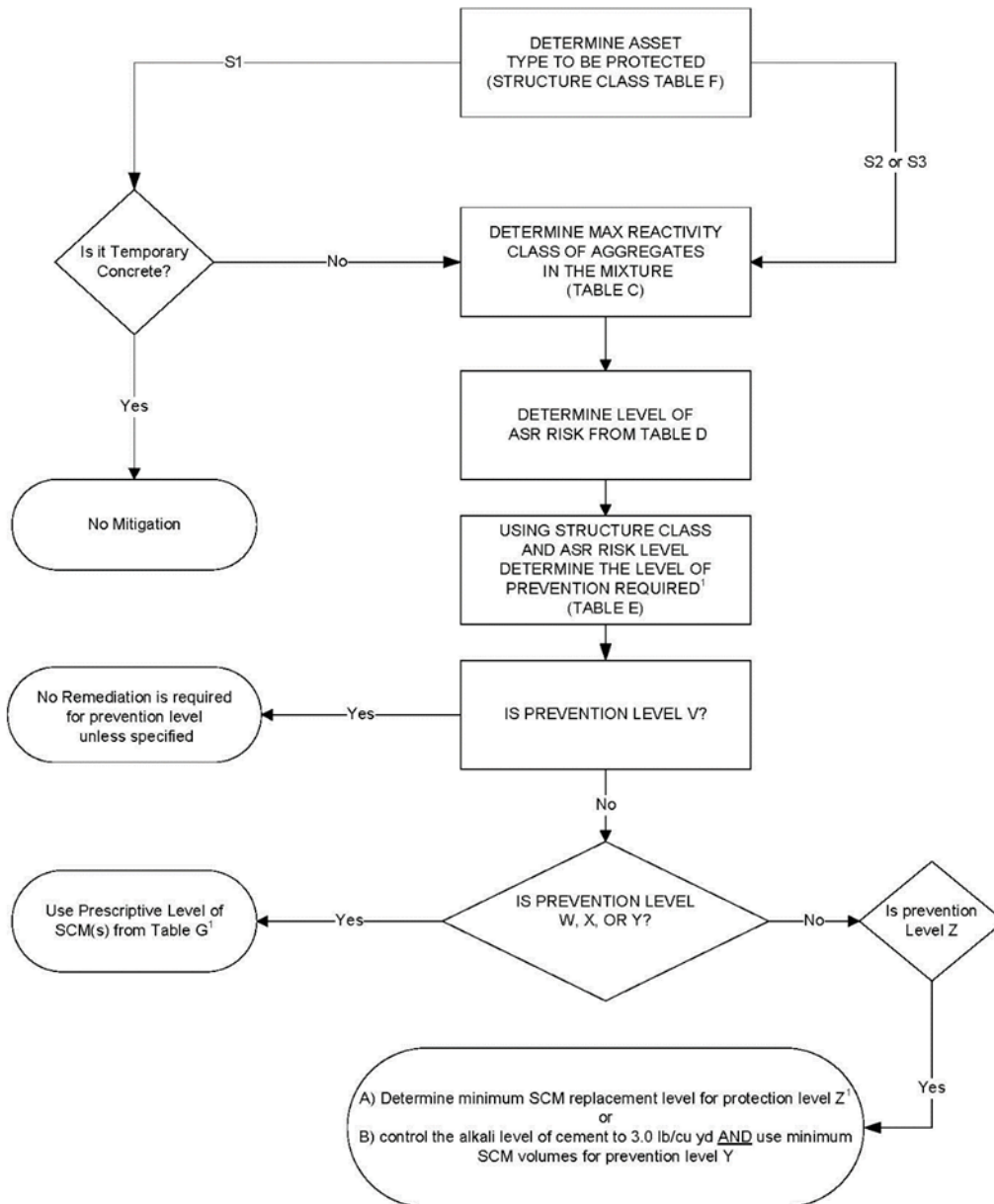

Note 1: The prevention level may be reduced by one level if low alkali cement (≤ 0.70) is used.

4. Admixture Requirements. Furnish chemical admixtures as specified in Section 711.3.

5. Exceptions. If a service record of nonreactivity can be documented, the Department may exempt aggregates

classified through testing as potentially reactive, as specified in Section 704.1(g)2, from the cement/cement-SCM requirements as specified in Section 704.1(g)3.c. The service record must include a minimum of 10 structures, each over 10 years of age and preferably over 15 years of age.

Include the following documentation in the service record:

- A report on the visual examination of each structure for cracking including expansion at joints where applicable.
- Structure type and age.
- Concrete class or mix design proportions if available.
- Cement and alkali content of the cement used during construction.
- Use and type of all SCMs used in the mixture/structure.
- Presence and type of symptoms of distress if found.

Take cores from a representative number of structures and perform petrographic analysis of cores according to ASTM C856 to determine the presence or absence of alkali-silica gel formations and associated microcracking.

Determination of the aggregate classification according to ASTM C295. This analysis must confirm the aggregates from the structures are similar in mineralogical composition to that of the aggregate currently being considered for use.

If field performance history and subsequent testing indicates an aggregate source has begun to form ASR expansion, no exception for use other than the prescriptive methods provided will be accepted.

(h) Extra Cement Concrete. If 25% extra cement is allowed rather than the standard use of an anti-washout admixture (AWA) as specified in Section 1001.3(k)3.a, the extra cement may be replaced with other cementitious material in the same proportions as established in the mix design or as specified in Section 704.1(c). Up to 50% of the water dose for the extra cementitious material, based on the water cement ratio of the mix being utilized, may be added. Add additional admixtures, other than an AWA, as required for performance or to meet other mixture criteria as specified.

704.2 PLANT AND TRUCK MIXED CEMENT CONCRETE—

(a) Batching Plant. Proportion cement, aggregates, water, and admixtures in a plant conforming to AASHTO M 157 for batching plants.

Install a moisture meter to accurately and continuously indicate the variability of the fine aggregate moisture content. If approved, automatic moisture compensating probes for fine and coarse aggregate may be used to control the amount of batched water. Calibrate moisture probes according to the reviewed QC Plan.

Provide scales with graduation increments no greater than 1/1000 of the total scale capacity to measure the weight of aggregates or cement. Increments of less than 5 pounds are not required. Provide scales with capacities approximately equal to the hopper capacity or the central mixer capacity under normal proportioning conditions.

Provide a minimum of ten 50-pound weights at the plant for checking the scale's accuracy. Store the weights in a manner to maintain their weight-calibration accuracy.

Check the accuracy of the bin scales according to PTM No. 410.

Provide the plant with the following equipment for developing the concrete design and to control the quality of aggregates used and the concrete produced:

Number of Each	Equipment
1	Sample splitter for fine aggregate having an even number of equal width chutes that discharge alternately to each side of the splitter. A minimum of 12 total chutes is required. The minimum width of the individual chutes is to be at least 50% larger than the largest particles in the sample and the maximum width of the individual chutes is to be 3/4 inch. Include two receptacles to hold the samples following splitting. Splitter design must allow samples to flow smoothly without restriction or loss of material.
1	Sample splitter for coarse aggregate having an even number of equal width chutes that discharge alternately to each side of the splitter. A minimum of eight total chutes is required. The minimum width of the individual chutes is to be at least 50% larger than the largest particles in the sample. Include two receptacles to hold the samples following

	splitting. Splitter design must allow samples to flow smoothly without restriction or loss of material.
	Or
1	Adjustable sample splitter for both coarse aggregate and fine aggregate having an even number of equal width chutes that discharge alternately to each side of the splitter. A minimum of 12 total chutes is required. For coarse aggregate, the minimum width of the individual chutes is to be at least 50% larger than the largest particles in the sample. For fine aggregate, the minimum width of the individual chutes is to be at least 50% larger than the largest particles in the sample and the maximum width of the individual chutes is to be 3/4 inch. Include two receptacles to hold the samples following splitting. Splitter design must allow samples to flow smoothly without restriction or loss of material.
1	Mechanical Sieve Shaker (with timer)—PTM No. 616
1 Set Each	Standard Sieves for Fine and Coarse Aggregate—ASTM E 11
1	Oven capable of maintaining a uniform temperature of 230F ± 9F—PTM No. 616
1	Calculating machine
1	Cylindrical Metal Measure 1 cubic foot— AASHTO T 19 and T 121, ASTM C136
1	Air Meter, acceptable type— AASHTO T 196 and T 152
1	Slump Cone— AASHTO T 119
1	Cylinder Compression Machine—PTM No. 604 ⁽¹⁾
1	Curing Tank—PTM No. 611 ⁽²⁾
1	Capping Device—PTM No. 604 ⁽¹⁾
1	Balance conforming to the requirements of AASHTO M 231 for the class of general purpose scale required, for the principle sample weight of the sample being tested—PTM No. 616.
1	Platform scale conforming to the requirements of AASHTO M 231 for the class of general purpose scale required, for the principle sample weight of the sample being tested—PTM No. 616, and AASHTO T 121 and ASTM C136
Sufficient	6-inch by 12-inch Cylinder Molds—PTM No. 611
	Necessary Incidental Equipment
1	Maturity Meter—PTM No. 640, if used
Sufficient	Temperature Sensors—PTM No. 640 if used

Note (1)—Equipment requirements may be waived if arrangements for testing have been made at the producer's central facility or at a commercial testing laboratory that participates in the AASHTO Accreditation Program in the area of Concrete Testing. Commercial testing laboratories are to conform to ASTM E329 for Concrete Inspection and Testing except for the equipment listed above.

Note (2)—Equipment requirements may be waived if, after 24 hours (±2 hours), specimens made for checking the strength of trial mixes are properly transported to a central facility or commercial testing laboratory for curing according to PTM No. 611.

Provide the plant with proper laboratory equipment, space, and utilities as specified in Section 609.

(b) Mixers and Agitators. AASHTO M 157. If directed, test air content of individual mixed concrete samples taken approximately at the beginning, the midpoint, and the end of the batch. If the air content varies by more than 1.5%, discontinue the use of the mixer or agitator until the condition is corrected.

If mixing in truck mixers at the plant, use inclined-axis, revolving-drum type mixers or horizontal-axis, revolving-drum high-discharge type mixers.

(c) Mixing and Delivery. Maintain concrete temperature after mixing between 50F and 90F for general concrete, and between 50F and 80F for bridge deck concrete. Do not ship concrete exceeding these temperature ranges. Maintain adequate two-way communications between the concrete plant and the work site to provide both uniformity and control of the concrete mixture.

For each truck, transmit a delivery ticket to the Representative at the time of each delivery (according to AASHTO M 157) with the following information:

- Contract number, complete state project number or purchase order number.

- The concrete plant supplier code.
- Method of concrete mixing (i.e., central or truck).
- Class of concrete, JMF number, and trial mix number (i.e., trial #1, 2, etc.).
- Number of cubic yards.
- Time of completion of mixing.
- Unique Truck ID.
- Number of mixing revolutions, if applicable.
- Total amount of batch water used in each truck (pounds).
- The total weight in pounds of the total cementitious materials.
- The types of additives used in each truck (i.e., water reducer, AEA, retarder, etc.).

Transmit the information on the batcher-mixer slip Form CS-4220 to the Representative. Do not use any concrete until it is approved for use by the Representative.

Conform to AASHTO M 157, except as follows:

- If mixing in a plant, mix for not less than 50 seconds or more than 90 seconds for normal strength concrete, and not less than 70 seconds for HES concrete.
- If mixing in the truck drum at the plant, mix for not less than 70 or more than 125 truck-drum revolutions, at a mixing speed of not less than 6 truck-drum revolutions per minute (rpm) nor more than 18 truck-drum rpm. Upon completion of the designated number of mixing revolutions, reduce the truck-drum speed to not less than 2 rpm or more than 6 rpm. Do not exceed a total of 300 truck-drum revolutions.

Deliver the mixed concrete to the work site and discharge within 1 1/2 hours after completion of mixing. As an alternative, use a set retarding admixture or a workability retention admixture or both, listed in Bulletin 15 and according to manufacturer's dosage recommendations, to extend the initial set time and time for discharge to 2 hours after the completion of mixing. Agitate, but do not mix the concrete en-route to the work site.

- In hot weather, under conditions contributing to quick concrete stiffening, or if the concrete temperature is 80F or above, do not allow the time between completion of mixing and discharge to exceed 1 hour. As an alternative to maintaining the concrete temperature below 80F, use an approved, set retarding admixture to extend the initial set time and enable the mix to remain workable for the full 1 1/2 hours of allowable mixing time.
- If using mixer or agitator trucks, agitate concrete for at least 20 revolutions immediately before placement. Do not use concrete that has exceeded 45 minutes without agitation.
- If wash water is used to clean the truck drum, completely discharge this wash water before the introduction of the succeeding batch.
- Do not allow concrete to come in contact with aluminum unless the aluminum is coated with an acceptable coating (delivery of concrete in an aluminum truck bed is allowed).

(d) Clean Out Areas. Concrete clean out areas, either contractor designed, or detailed within the contract documents, are incidental.

704.3 VOLUMETRIC MIXED CEMENT CONCRETE

(a) General. Use a plant inspected and listed in Bulletin 42. Make trial mixtures with a calibrated mixing plant. Provide plant equipment, facilities, and a concrete technician(s) as specified in Section 704.1. Do not begin production until the mixing plant and all equipment and facilities necessary for performing the work have been inspected and accepted. Mixing plants may be truck mounted.

(b) Usage. Volumetric mixing plants may be used to produce concrete for endwalls, inlets, manholes, end anchors, sign posts, and similar miscellaneous structures requiring small quantities of concrete. If allowed by the District Executive in writing, volumetric mixing plants may also be used for pavement patching and structures. Approved plants may produce concrete for precast items.

(c) Equipment. Prominently attach a permanent metal plate(s) to the plant plainly marking the gross volume in terms of mixed concrete, the operating speed, the plant auger mixing angle, and the plant weight-calibrated cement constant in terms of a revolution counter or other output indicator, all as rated by the manufacturer.

1. Compartments. Provide separate compartments to carry the ingredients. Cover the aggregate bins and prevent contamination and intermixing of the fine and coarse aggregates during loading and transporting. Keep the cement bins free of moisture and contamination. Provide suitable means to carry water and additives and to incorporate the additives with the mixing water in the mix.

2. Feed System. Provide a feeder system mounted under the compartment bins to deliver the ingredients to the mixing unit. Equip each bin with an accurately controlled individual gate to form an orifice for volumetrically measuring the material drawn from the bin compartment. Do not charge aggregate bins more than 4 hours before mixing.

Set the cement bin feeding mechanism to discharge a given volumetric weight equivalent of cement at a continuous and uniform rate during the concrete mixing operation. Coordinate the coarse and fine aggregate feeding mechanisms with the cement feeding mechanisms to deliver the required proportions.

3. Mixing Unit. Provide an auger-type mixer incorporated in the plant's discharge chute, or another suitable mixing mechanism that produces concrete of uniform consistency and discharges the mix without segregation. Examine the mixing screw daily and clean as necessary to prevent the build-up of mortar or concrete.

4. Dials and Measuring Devices. Equip the plant with accurate revolution-counter indicators that allow the volumetric weight equivalent of cement, fine aggregate, and coarse aggregate discharged to be read during the concrete-mixing operation. Equip the counter with a ticket print-out to record this quantity.

Equip the plant with a water flow meter or gauge to indicate the discharge rate of water (by volume) entering the mix and a water meter to register the total amount of water discharged during the mixing operation. Also, equip the plant with suitable gauges for checking the rate of flow of all additive(s) entering the mix. Coordinate the water and additive flow meters with the cement and aggregate feeding mechanisms. Equip the flow meters with scales appropriate for the type and amount of material being measured. Mount a tachometer indicating the drive shaft speed on the plant.

Place gauges, dials, and other devices that indicate the accuracy of concrete proportioning and mixing in full view so the operator can accurately read or readjust them while concrete is being produced. Provide the operator convenient access to all controls.

(d) Calibration. Use a unit constructed to allow convenient calibration of the gate openings and meters. Conduct a calibration once a year in the presence of Department representatives. Make satisfactory arrangements with the Department at least 1 week in advance of calibration. During the yearly calibration, calibrate the cement meter according to the manufacturer's recommendation and check the aggregate gate settings against the calibration data for the plant. Maintain the calibration data in the plant and submit the data to the District.

After performing the yearly calibration and before starting work, provide a mix design for review and acceptance and run a yield test to verify the design. Adjustments to correct for yield may require recalibration or a design change.

Conduct a recalibration if there is a change in the source of fine or coarse aggregate or cement. Conduct additional calibrations if directed. Provide each plant with data on the accepted recalibration.

If hydraulic drive units are used, perform the following additional calibration procedure: At the beginning of the actual batching operation, check the cement meter against the count and time used for the cement during the calibration

of the individual materials. If a discrepancy occurs, adjust the belt speed of the unit so the actual cement meter count does not vary from the calibrated meter count by more than two counts per 60 seconds.

(e) Mixing and Delivery. Proportion, measure, and batch cement and aggregates by a weight equivalent method. The measuring and batching mechanism is required to produce the specified proportions of each ingredient within the following tolerances:

- Cement, Weight 0 to +4%
- Fine Aggregate, Weight ±2%
- Coarse Aggregate, Weight ±2%
- Admixtures, Weight or Volume ±3%
- Water, Weight or Volume ±2%

The tolerances are based on a volume/weight relationship established during the calibration of the measuring devices.

During mixing, maintain the drive shaft speed, as indicated by the tachometer, within 50 rpm of the operating speed. Set the auger mixer angle in the range determined by the manufacturer. Do not exceed 1/2 hour between the continuous placing of succeeding batches.

1. Testing. Conduct slump and air content tests according to PTM No. 601. Conduct the unit weight test, the concrete uniformity test, and the output meter calibration test according to AASHTO T 121, ASTM C136, AASHTO M 157, and PTM No. 626. If there is any doubt in the uniformity of the concrete, perform further testing as directed.

2. Recording. Provide a batcher mixer slip with each load of ingredients. Include the following information on the batcher mixer slip:

- Aggregate and moisture information.
- Class of concrete and the corresponding dial setting, as determined in the design.
- Water discharge rate limitations.

Use a separate batcher mixer slip for each class of concrete. Deliver the batcher mixer slip to the Representative at the work site. Do not use the concrete until the Representative verifies the data noted on the slip complies with the specifications.

(f) Clean Out Areas. Concrete clean out areas, either contractor designed, or detailed within the contract documents, are incidental.

Concrete Technician Certification Program

FIELD TECHNICIANS

Initial Certification Requirements, Recertification
Requirements and Application Procedures

Bureau of Construction and Materials, Construction Quality
Assurance Division

TABLE OF CONTENTS

<u>SECTION</u>	<u>PAGE</u>
I. BACKGROUND	3
II. TECHNICIAN-IN-TRAINING	4
III. INITIAL CERTIFICATION	5
IV. RE-CERTIFICATION	6
V. FAILED EXAMINATION	7
VI. PERFORMANCE REVIEW PROCESS	8
VII. CONCRETE TECHNICIAN CODE OF ETHICS	12
CONCRETE FIELD TECHNICIAN IN TRAINING EVALUATION CS-536TT	14

I. BACKGROUND

This publication provides information concerning the minimum requirements needed to become a Certified Concrete Technician doing work for the Pennsylvania Department of Transportation, and the requirements to maintain the certification. These requirements are part of the Department's technician certification program developed to satisfy the requirements circulated in the Code of Federal Regulations, 23 CFR, Part 637, Quality Assurance (QA) Procedures for Construction, issued June 29, 1995. These Federal Regulations contained the following statement:

“After June 29, 2000, all sampling and testing data to be used in the acceptance decision or the independent assurance program will be executed by qualified sampling and testing personnel.”

In response to the Federal regulation, the Department began development of a concrete technician certification program. The program included two components:

- 1) American Concrete Institute (ACI) Concrete Field Testing Technician – Grade 1
- 2) PennDOT Certified Concrete Field Testing Technician

This publication includes the minimum requirements for Technician-in-Training Certification, Initial Certification and Recertification and the application procedures for applicants requesting to become certified concrete technicians as follows:

- PennDOT Certified Concrete Field Technician-in-Training
- PennDOT Certified Concrete Field Technician

For the Technician-in-Training category, the certification period will be for one (1) year from the date of approval by a DME/DMM or their representative.

The initial certification for a PennDOT Certified Concrete Field Technician will be for approximately five (5) years and any subsequent recertification will continue the technician's certification for approximately an additional five (5) years.

The Northeast Center of Excellence for Pavement Technology (NECEPT), located at the Pennsylvania State University (PSU), is PennDOT's Administrator for the Concrete Technician Certification Program.

II. PennDOT CONCRETE FIELD TECHNICIAN-IN-TRAINING CERTIFICATION

A. Technician-in-Training Certification Requirements

1. Applicant must have a minimum of 24 hours (3 full working days) of documented work experience on a PennDOT project under the direct instruction and supervision of an individual who is a PennDOT Certified Concrete Field Technician. Experience must have been obtained within the last three months.
2. Applicant must have a signature from and the certification number (issued by PennDOT) of the technician who directly instructed and supervised them for the minimum work experience required above.
3. Applicant must submit a completed PennDOT Concrete Field Technician-in-Training Evaluation Form to the District Materials Engineer/District Materials Manager (DME/DMM) for the District where the project is located.
4. The DME/DMM or their representative will evaluate the applicant. Upon satisfactorily completing the evaluation, the DME/DMM or their representative will sign the evaluation form and provide the applicant with the signed original.
5. The DME/DMM is to maintain a copy of the evaluations and forward a copy to:

PennDOT Certified Concrete Tech.-in-Training Administrator
Bureau of Construction and Materials
Construction Quality Assurance Division
81 Lab Lane
Harrisburg PA 17110-2543
6. The PennDOT Certified Technician-in-Training Certification is valid for one (1) year from the date of issuance by the DME/DMM and will be acceptable in ALL Districts for that period.
7. Applicant must complete the Certification procedures in Section III as soon as courses are available and within a maximum of one (1) year. Applicants who do not complete Certification procedures within one year will not be granted another Technician-in-Training, but will be subject to the initial certification requirements covered in Section III.

B. Re-Certification Procedures

1. An individual may only receive Technician-in-Training status for the initial (1) year they were certified. The technician MUST then become a PennDOT Certified Concrete Field Technician by following the Initial Certification procedures covered in Section III.

III. PennDOT CERTIFIED CONCRETE FIELD TECHNICIAN – INITIAL CERTIFICATION

A. Initial Certification Requirements

1. Applicant must have obtained status as a PennDOT Certified Concrete Field Technician-in-Training, OR completed two (2) construction seasons working in concrete field or plant operations.
2. Applicant must successfully complete ACI's Concrete Field Testing Technician – Grade 1 Course
3. Applicant must successfully complete PennDOT's Certified Concrete Field Testing Technician Course.

Note: A Concrete Field Technician in Training may temporarily be assigned a Concrete Field Technician status until the next available PennDOT Concrete Field Technician Course, if agreed to in writing by a DME/DMM.

B. Initial Certification Application Procedures

1. Attend and successfully complete the ACI Concrete Field Testing Technician – Grade 1 Course.

ACI issues a wallet-sized card to the individual upon successful completion of the course. Acceptable proof of having completed the course is a photocopy of the applicant's current ACI Concrete Field Testing Technician – Grade 1 wallet-sized card.

This requirement need only be completed once in the applicant's career provided their status as a Certified PennDOT Concrete Field Technician continues uninterrupted.

2. Upon successful completion of the ACI Concrete Field Testing Technician – Grade 1 Course requirement above, the applicant should apply to take the next available PennDOT Certified Concrete Field Technician Course. The applicant must register online and submit a photocopy of their ACI wallet-sized card to NECEPT. Paper applications will not be accepted.
3. Attend and successfully complete the PennDOT Certified Concrete Field Testing Technician Course. The applicant may attend a maximum of two (2) PennDOT Certified Concrete Technician courses per NECEPT training season.
4. The Department or its administrative representative will issue a wallet-sized card upon successful completion of the above requirements. This card will be valid for a period of approximately five (5) years, expiring on April 30. For courses or retest exams held December through April, the card will remain valid for 5 years plus the remaining days to reach April 30. For courses or exams after April 30 through the end of the retest period, the card is valid for a period slightly less than 5 years to the April 30 date.

Note: Should an individual allow their status as a PennDOT Certified Concrete Field Technician to lapse, the Department will require them to retake and successfully complete a current ACI Concrete Field Testing Technician – Grade 1 course.

IV. PennDOT CERTIFIED CONCRETE FIELD TECHNICIAN - RE-CERTIFICATION

A. Re-Certification Requirements

1. Applicant must be a current PennDOT Certified Concrete Field Technician.

B. Re-Certification Application Procedures

1. Complete the online registration for Re-certification as a PennDOT Certified Concrete Field Technician. Paper applications will not be accepted.
2. Attend and successfully complete the PennDOT Certified Concrete Field Testing Technician Course. The applicant may attend a maximum of two (2) PennDOT Certified Concrete Technician courses per NECEPT training season. See Section V for details on attending more than one (1) course per training season.
3. The Department or its administrative representative will issue a new wallet-sized card upon successful completion of the above requirements. This card will be valid for a period of approximately five (5) years, expiring April 30. For courses or retest exams held December through April, the card will remain valid for five (5) years plus the remaining days to reach April 30. For courses or exams after April 30 through the end of the retest period, the card is valid for a period slightly less than five (5) years to the April 30 date.
4. The wallet-sized card is valid up until the Expiration Date. If the applicant's certification is expired, the applicant must provide a current ACI Certification when registering for Re-certification.

V. FAILED EXAMINATION

Applicants who do not pass the examination for PennDOT Certified Concrete Field Technician will have two (2) options.

- Option 1: Applicants may register for and attend one additional regularly scheduled PennDOT Certified Concrete Technician course, provided there are courses remaining and sufficient space to accommodate them. If an applicant fails this additional course, they will still be eligible to take a retest. The full registration cost will be charged to retake the course.
- Option 2: Applicants may take a retest. There will be two (2) retest dates offered after all of the regularly scheduled classes have been completed. Prior to the retest there will be a brief review of key program highlights which were covered during the initial course and a question-and-answer period for all participants. Applicants are strongly encouraged to review all course materials on their own before the day of the retest. A fee will be charged for any retest with the fee amount and method of payment indicated on the current online registration.

Applicants failing to schedule or pass an additional course or retest within the current NECEPT training season will lose their PennDOT Certified Concrete Technician certification on April 30th provided their current certification is expired. Applicants without a valid PennDOT Certified Concrete Technician certification will be required to register during the next NECEPT training season following the guidelines established for initial certification in Section III.

Applicants may attend a maximum of two (2) PennDOT Certified Concrete Technician courses and take a maximum of one (1) retest per NECEPT training season. After the online registration is completed and payment is received, NECEPT will send confirmation to the applicant.

VI. PERFORMANCE REVIEW PROCESS

A. Purpose and Makeup

The performance review process evaluates the performance of PennDOT Certified Concrete Field Technicians to determine if their substandard performance or intentional misrepresentation requires any action to be taken against their current certification status. The review of a certified Concrete technician's substandard performance or intentional misrepresentation will be conducted by the Concrete Technician Certification Board (CTCB). The CTCB is composed of the representation shown in Table 1.

Organization	Number of Representatives
PennDOT-Bureau of Construction and Materials	1
Pennsylvania Aggregates and Concrete Association (PACA)	1
Administrator of Certification Program for PennDOT (currently NECEPT)	1

Representatives to the CTCB will be identified by their organization through a scheduled meeting of the Concrete Paving Quality Improvement Task Force (CPQITF) or other official means. Each representative will serve for a three-year term. Representatives may serve on the CTCB for an unlimited number of consecutive terms.

In general, the review process will rely on written documentation of a PennDOT Certified Concrete Field Technician not following practices identified in the Certification Course or intentionally misrepresenting quality of the work. The written documentation should only be provided to the CTCB after the PennDOT Certified Concrete Field Technician has been verbally notified that they are not following practices identified in the Certification Course or that they have intentionally misrepresented quality of the work. The CTCB will review the written documentation and allow for an interview prior to making a determination on the certification status of the PennDOT Certified Concrete Field Technician.

B. Procedure

1. PennDOT Certified Concrete Field Technician Not Following Practices, Procedures and Specifications

The official procedure when a PennDOT Certified Concrete Field Technician is not following, or has not followed, practices identified as acceptable PennDOT practices, procedures and specifications, is as follows:

- a. A PennDOT, Consultant, Industry or other Certified PennDOT Concrete Field Technician, hereafter referred to as the Observer, observes another PennDOT Certified Concrete Field Technician, hereafter referred to as the technician, not following a practice or practices identified in the Certification Course.

Immediately, the Observer is to verbally notify the technician that they are not following a practice or practices identified in the Certification Course. The Observer must record the verbal notification, including the time, date, location, technician's name and company or organization, and the specific practice or practices not being followed.

- b. If a second occurrence is observed where the same technician is not following a practice or practices identified in the Certification Course, immediately, the Observer is to again verbally notify the technician that they are not following a practice or practices identified in the Certification Course. In addition, the Observer must notify the technician's supervisor, by verbal or written communication, that the technician is not following a practice or practices identified in the Certification Course and that the technician has been verbally notified for two occurrences. The Observer is to record the second occurrence and the notifications given to the technician and the technician's supervisor as detailed in VI.B.1.a. above. In addition, the Observer is to record the name of the technician's supervisor, the date, and the time (if verbal notification was given) that the supervisor was contacted.
- c. If a third occurrence is observed where the same technician is not following a practice or practices identified in the Certification Course, immediately, the Observer is to again verbally notify the technician that they are not following a practice or practices identified in the Certification Course. In addition, the Observer is to officially document the entire situation. The official documentation should provide as much detail as possible, providing as a minimum, the full name and certification number of the Observer, the S.R., Section, Contract Number, Plant Name and Location, the full name and certification number of the technician, and the full name of the technician's supervisor. The Observer is to provide copies of all previously recorded verbal or written notifications and a detailed account of the entire situation. Only one document will be accepted by the CTCB per situation and, for this reason, it is important to include all pertinent information in this documentation. Pending action by the CTCB, the technician will be temporarily suspended.
- d. Upon the third occurrence of the same technician not following a practice or practices identified in the Certification Course, the technician will be removed from the project or plant, may be restricted in the work they can do, or may be temporarily suspended until the situation is reviewed by the CTCB. If temporarily suspended, the technician must immediately forfeit their valid wallet-sized certification card to the DME/DMM or appropriate Department personnel. The DME/DMM or appropriate Department personnel will hold the confiscated wallet-sized certification card. The temporary suspension will restrict the technician from doing any technician work, including materials testing or materials certification, on Department construction or maintenance projects or any projects using liquid fuels tax monies.
- e. The Observer is to provide one photocopy of the documentation to the technician and retain one photocopy in their project or plant office files. The Observer is to submit the original copy of the documentation to the Chairperson of the Concrete Technician Certification Board at the address below:

Chairperson, Concrete Technician Certification Board
PA Department of Transportation
Bureau of Construction and Materials
Construction Quality Assurance Division
81 Lab Lane
Harrisburg PA 17110-2543

Submit documentation within 14 calendar days of the date of the third occurrence. Documentation not received by the Bureau of Construction and Materials within 21 calendar days of the third occurrence will be void.

- f. The technician will be afforded the opportunity to submit a written appeal to the Chairperson of the CTCB at the address indicated in VI.B.1.e. and the opportunity to appear before the CTCB. The technician is to provide one photocopy of the appeal to the Observer and to retain one photocopy for their project files. Only one written appeal will be accepted by the CTCB per situation and, for this reason, it is important to include all pertinent information in the written appeal. Submit written appeals to the Chairperson of the CTCB within 35 calendar days of the documented third occurrence. Appeals received more than 40 calendar days after the third occurrence will be void.
- g. The documentation and written appeal (if provided) will be logged by the Bureau of Construction and Materials and then forwarded to the chairperson of the CTCB for action.
- h. The chairperson of the CTCB will review the documentation and the appeal (if provided) with the other members of the CTCB. The CTCB will provide a written response to the Bureau of Construction and Materials within 21 calendar days from the date the documentation was sent to the CTCB. The written response will provide the action that is to be taken concerning the situation. The written response of the CTCB will be final and will be logged and filed by the Bureau of Construction and Materials. Possible actions of the CTCB will include but are not limited to: CTCB written warning; CTCB written reprimand; CTCB certification suspension (1, 2, or 3 months); CTCB rescindment of certification. CTCB suspension or rescindment of certification will require the technician to forfeit their wallet-sized certification card to the CTCB.
- i. The Bureau of Construction and Materials will immediately forward the CTCB's written response concerning certification status to the technician.

2. PennDOT Certified Concrete Field Technician Involved in Deceptive, Questionable or Unethical Activities

- a. A PennDOT, Consultant, Industry or other PennDOT Certified Concrete Field Technician, hereafter referred to as the Observer, observes or becomes aware of an action of another PennDOT Certified Concrete Field Technician, hereafter referred to as the technician, which may be an attempt to mislead or deceive others about the quality of the materials, about materials testing, or about test results or, an action which may be questionable or unethical. Immediately, the Observer is to report the incident to the appropriate DME/DMM, or other appropriate Department personnel. The Observer and the DME/DMM, or other appropriate Department personnel, are to immediately contact any member of the CTCB. Initial contacts and information concerning these actions will be kept strictly confidential.
- b. The DME/DMM, or other appropriate Department personnel, will coordinate with the CTCB to institute an investigation of the action. The investigation will determine whether or not the deceptive, questionable, or unethical action was willful. The investigation will be documented to support the final determination.

- c. With support from the CTCB member initially contacted, and before the investigation is completed, the technician and the technician's supervisor or employer will be verbally notified immediately by the DME/DMM, or other appropriate Department personnel, that the technician will be restricted in the work they can do and will be temporarily suspended, until the investigation is completed and reviewed by the CTCB. If temporarily suspended, the technician must immediately forfeit their valid wallet-sized certification card to the DME/DMM or appropriate Department personnel. The DME/DMM, or appropriate Department personnel, will hold the confiscated wallet-sized certification card pending the investigation by the CTCB. Temporary suspension will restrict the technician from doing any technician work, including materials testing or materials certification, on Department construction or maintenance projects or any projects using liquid fuels tax monies.
- d. The DME/DMM, or other appropriate Department personnel, with coordination from the CTCB, will complete the investigation and officially document the entire incident and subsequent investigation. The documentation should provide as much detail as possible and be similar to the documentation required in VI.B.1.c. above. The DME/DMM or appropriate Department personnel will provide copies and submit the documentation as instructed in VI.B.1.e. above and within 21 calendar days of the verbal notification described in VI.B.2.c.
- e. The technician will be afforded the opportunity to submit a written appeal and request an interview with the CTCB. Provide copies and submit written appeals as instructed in VI.B.1.f. and within 35 calendar days from the date of the verbal notification described in VI.B.2.c. Appeals received more than 40 calendar days after the verbal notification described in VI.B.2.c. will be void.
- f. The documentation and appeal (if provided) will be considered by the CTCB as described in VI.B.1.g. to VI.B.1.i. above.

VII. PENNDOT CERTIFIED CONCRETE TECHNICIAN CODE OF ETHICS

The Concrete Technician Certification Board (CTCB) has found that the following rules are necessary to establish and maintain the high standard of integrity and dignity in the Concrete Technician profession and are to protect the public against unprofessional conduct on the part of the Concrete Technician. PennDOT Certified Concrete Field Technicians are put on notice that an ethical violation by themselves or by an individual rendering or offering to render Concrete Technician services under their supervision, as provided by this Publication, may result in disciplinary procedures against them in accordance with Section VI.B.2.

- A. Principle 1. Beneficence/autonomy. A PennDOT Certified Concrete Field Technician will demonstrate a concern for the welfare and dignity of the recipients of the services, including Department personnel.
1. A PennDOT Certified Concrete Field Technician will provide services without discriminating on the basis of race, creed, national origin, sex, age, handicap, disease, social status, financial status, or religious affiliation.
 2. A PennDOT Certified Concrete Field Technician will act for the client or employer in professional matters as a faithful agent or trustee, and will not accept a direct fee for services rendered as a certified Concrete technician from other than the technician's employer.
 3. A PennDOT Certified Concrete Field Technician will not attempt to injure falsely or maliciously, directly or indirectly, the professional reputation, prospects, or business of anyone.
 4. A PennDOT Certified Concrete Field Technician will not attempt to supplant another Concrete technician after definite steps have been taken toward that technician's employment.
 5. A PennDOT Certified Concrete Field Technician will not compete with another Concrete technician for employment by the use of unethical practices.
 6. A PennDOT Certified Concrete Field Technician will not review the work of another Concrete technician for the same client, except with the knowledge of such Concrete technician, or unless the connection of such Concrete technician with the work has terminated.
 7. A PennDOT Certified Concrete Field Technician will not attempt to obtain or render technical services or assistance without fair and just compensation commensurate with the services rendered: Provided, however, the donation of such services to a civic, charitable, religious, or eleemosynary organization will not be deemed a violation.
 8. A PennDOT Certified Concrete Field Technician will not advertise in selfpraising language, or in any other manner, derogatory to the dignity of the profession.
 9. A PennDOT Certified Concrete Field Technician will not create or participate in a threatening, intimidating, or hostile environment toward any recipients of services, including Department Representatives.

- B. Principle 2. Competence.** A PennDOT Certified Concrete Field Technician will maintain high standards of professional competence.
1. A PennDOT Certified Concrete Field Technician will not attempt to practice in work in which the Concrete Technician is not proficient or practice in work outside the standards of the profession.
 2. A PennDOT Certified Concrete Field Technician will consult with other service providers when additional knowledge and expertise is required.
 3. A PennDOT Certified Concrete Field Technician will accurately record and report information related to Concrete Technician services provided to the Department.
 4. A PennDOT Certified Concrete Field Technician will require those whom the Technician supervises in the provision of Concrete Technician services to adhere to this Code of Ethics.
- C. Principle 3. Public Information.** A PennDOT Certified Concrete Field Technician will provide accurate information about Concrete Technician services.
1. A PennDOT Certified Concrete Field Technician will accurately represent their competence and training.
 2. A PennDOT Certified Concrete Field Technician will not use or participate in the use of a form of communication that contains a false, misleading, or deceptive statement or claim.
 3. A PennDOT Certified Concrete Field Technician will not use or permit the use of their signature on work over which the technician was not in responsible charge.
- D. Principle 4. Professional Relationships.** A PennDOT Certified Concrete Field Technician will function with discretion and integrity in relations with colleagues and other professionals.
1. A PennDOT Certified Concrete Field Technician will report illegal, incompetent or unethical practice by colleagues or other professionals to the appropriate authority.
 2. A PennDOT Certified Concrete Field Technician who employs or supervises colleagues will provide appropriate supervision as necessary to provide Concrete Technician services in conformance with this Code of Ethics.

CS-536TT (9-22)

[Click here for the fillable form CS-536TT](#)



pennsylvania
DEPARTMENT OF TRANSPORTATION
www.penndot.pa.gov

CONCRETE FIELD TECHNICIAN-IN-TRAINING EVALUATION

A APPLICANT INFORMATION

First Name:	Middle Initial/Name:	Last Name:	
Mailing Address:		Daytime Phone:	
City:	State:	Zip Code:	
Employer Name:		Job Title:	
A certified PennDOT Technician must provide the above named applicant with (3) days of training prior to evaluation by DME/DMM or their representative			
Certified PennDOT Technician Signature: _____			
Certified PennDOT Technician No.: _____		Date: _____	

B APPLICANT EXPERIENCE / INSTRUCTION TO BE A CONCRETE FIELD TECHNICIAN IN TRAINING

To become a Technician-in-Training, the individual must be able to demonstrate the ability to perform the following:

1. Sampling Fresh Concrete - PTM 601 & AASHTO R 60 Y N
2. Test for Material Temperature - ASTM C1064 - AASHTO T309 Y N
3. Test for Slump of Fresh Concrete - AASHTO T119 Y N
4. Test for Air Content of Fresh Concrete (Pressure Method) - AASHTO T152 Y N
5. Molding of cylinder specimens - PTM 611 14 Y N
6. Calibrating an air meter using manufacturer's methods & AASHTO T152 Y N
7. Calculate a water/cement ratio for a specific truck load Y N
8. Demonstrate a knowledge of Pub. 408, Section 704 slump specification requirements Y N

In addition, to the above (8) areas, if the technician is expected to work on a project using lightweight concrete or concrete with slag aggregates, they should also be able to perform the following:

9. Test for Air Content of Fresh Concrete (Volumetric Method, Roll-a-meter) - AASHTO T196 Y N
10. Unit Weight, Yield & Gravimetric Air Content - AASHTO T121 Y N

Note: The PennDOT Certified Technician-in-Training Certification is valid for one (1) year from the date of issuance by the DME/DMM and will be acceptable in ALL Districts for that period.

Remarks:

C D.M.E./D.M.M./or their Rep. Signature: _____

Name (Print):	District:	Date:
---------------	-----------	-------